

wesco

© 2024

Raising children to raise the world



The catalog for ages 0/6
LEARNING IS FUN



World Leader
in Soft Play and Active Play





Welcome
to
wesco®



Since 1975, Wesco's commitment to designing, selecting and manufacturing innovative products for children aged 0 to 6 has been unwavering.

The well-being of children
our driving force

Every day, our teams work diligently to fulfill our corporate mission: For children to awaken the world! We admire the potential of all children and are equally attentive to their individual needs. For us, diversity is an opportunity and it drives us year after year to offer a range of new, innovative products.

The customer
at the center of our concerns

Alongside early childhood professionals, schools, nurseries, we have forged a lasting and trusting relationship for more than 45 years. More than ever, our desire is to maintain our high standards and surpass your expectations by always offering you more innovative products and services.

Tomorrow
is imagined today

We are all mobilized to take care of the future of children. Every day our choices are guided by our values: offering creative products, reducing our impact on the environment, raising children's awareness of the challenges of tomorrow and living well together... Continuous improvement is the heart of our approach



2 - 49

**LAYOUT
AND FURNITURE**



50 - 55

GAMES



56 - 115

**SPORT
AND MOTOR SKILLS**



Relaxing area

White furniture for a better reflection of light patterns!

The colours created by the light patterns allow children to experience unique moments, awakening their senses so that they develop improved body awareness.



Covered in comfortable, resistant and ultra-safe vinyl fabric for intensive use and easy cleaning.

High-density foam (1,5 lbs/ft³) will not sag over time and does not pose any injury risk to children.

A BABY WALL MAT 37 3/4 x 19"
Thickness: 2".

67 534 each

B BABY WALL MAT
With mirrors Single
L: 37 3/4" - W: 19" - th: 2".

67 535 each

C Basic LOW CORNER
CHAIR H: 6 3/4"
W: 17 3/4" - H: 14 3/4" - D: 15 3/4".
Seat: H: 6 3/4" - D: 9 1/2".

67 541 each

D Basic QUARTER CIRCLE
POUFFE H: 6 3/4"
W: 15 3/4" - H: 6 3/4".

67 538 each

E BASE FOR LIGHT TUBE
Ø 1/2".
Side: 19" - H: 9 3/4".

56 731 each

F CUSHION 2 3/4"
Ø 13 3/4" - H: 2 3/4".

67 510 each

G Basic SMALL SQUARE
CUSHION H: 6 3/4"
W: 11 3/4" - H: 6 3/4" - D: 10 1/4".

67 537 each

A

B

J

C

G

D

E

F

H

I

K

L

M

H Mosaic MAT 37 3/4 x 19"
Thickness: 1 1/2".

67 517 each

I Mosaic CONTAINER
L: 19" - W: 19" - H: 9 1/2".

67 536 each

J Basic STRAIGHT LOW CHAIR
H: 6 3/4"
W: 11 3/4" - H: 14 3/4" - D: 15 3/4".
Seat: H: 6 3/4" - D: 9 1/2".

67 539 each

K CONVERTIBLE CHAIR
Folded: L: 19" - W: 23 1/2" - H: 19 1/4"
Unfolded: L: 56 3/4" - W: 23 1/2" -
H: 12 1/2". Sleeping area: L: 49 1/2".

67 518 each

L Kia Child SEAT
L: 18" - W: 14 1/2" - H: 18 1/2".

67 548 each

M ARMCHAIR Club - H: 9 3/4"
L: 22 3/4" - W: 17 3/4" - H: 21 3/4".

20 021 each

A really cosy space, created in the blink of an eye!



Safe: highly resistant vinyl fabric for intensive use in communities.

The thick foam walls (2 3/4") dampen noise and promote a renewed sense of calm.

Easy to clean: wipes clean with a soft cloth or sponge, and cold soapy water

Saves space: the cabin can be dismantled and stored flat!

wesco
design

2 YEAR GUARANTEE

MADE IN CANADA

Complies with standard EN 1021-1 and 2: flammability of filled furnishings

Delivered flat-packed, do-it-yourself installation.

From birth
SENSORY CABIN

The thickness of the foam reduces noise and protects the child from injury. The vinyl fabric is suitable for intensive group use and is easily cleaned.

Consists of: 4 walls with a thickness of 2 3/4", a 1 1/2" thick floor mat and a vinyl covered roof.

L: 47 1/4" - W: 47 1/4". Made from FOAM and COATED FABRIC. washable with water. Indoor use.

Delivered flat-packed, do-it-yourself installation. Colours WHITE (001)

53 916 each



N + 12 months
Sensory Baby TILE Side: 19" - th: 1/2" Made from VINYL COVERS, washable with a sponge. Indoor use. Colours WHITE/IVORY (212)
62 481 each

O + 18 months
BEANBAG CHAIR Comfortable and fun, this beanbag shapes itself to your body for a better seating position. L: 21 3/4" - W: 21 3/4" - H: 33 1/2". Made from JERSEY-lined COATED FABRIC, filled with POLYSTYRENE MICROBEADS. washable using a soft cloth in cold soapy water. Choice of colours: WHITE (001) - LIGHT BLUE / IVORY (186) - LIGHT GREEN / IVORY (187) - LIGHT ORANGE/IVORY (222)
37 674 each

P + 2 years
CHILD'S MONOBLOC DECKCHAIR with comfort cushion Our children's deckchair has become a must-have: it owes its success to its strength, lightness and easy maintenance. We've fitted it with a cushion to make it even more comfortable for hours of relaxation! L: 28 1/4" - W: 17 3/4" - H: 17 1/4". washable with a sponge. Indoor use. Choice of colours: WHITE (001) - LIGHT BLUE (057) - LIGHT GREEN (037) - LIGHT ORANGE (164)
45 218 set

Q + 18 months
Cosy LARGE BALL POOL Without balls Consists of: 4 sections and 1 base mat. L: 74 3/4" - W: Side 74 3/4" - H: 14 1/2" - th. 7 3/4". Comes without a ball. Choice of colours: WHITE (001) - LIGHT BLUE / IVORY (186) - LIGHT GREEN / IVORY (187) - YELLOW/IVORY (209)
00 856 set

R **TRANSPARENT BALLS x250** Transparent for improved visibility of the children in the ball pools. Ø 3 1/4". Made from POLYETHYLENE. PLASTIC. Choice of colours: WHITE (001) - BLUE (002) - GREEN (008) - YELLOW (014) - ORANGE (007) - MULTICOLOURED (020)
34 293 pack of 250

Sensory motor skills

Encourage movement *through sensory experience!*

Through touch, the child puts words to the feelings they experience, boosting their language learning and exchanges with others. A great source of sharing and discovery!



Stimulate tactile perception.
Stimulate the vestibular system.



From eco-managed
forests

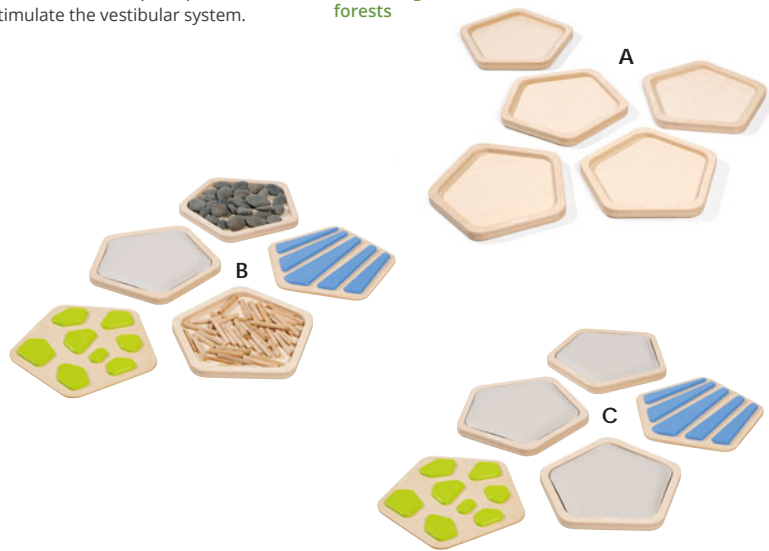

SENSORY WOODEN TILES These wooden tiles can be placed side by side to form the suitable sensory path(s) for each need by adding natural materials such as sand, leaves, feathers and more. Touch, discover and smell: these sensory tiles encourage children to become aware of their body and improve their balance by stimulating tactile awareness through the hands or feet. Tile: L: 13 1/2" - W: 13 1/2". Made from varnished PLYWOOD. Washable using a soft cloth in cold soapy water. Indoor use.

pack of 5

A Kit to fill	+ 12 months	5 hollow tiles.	63 374
B Sensory 1 kit	+ 12 months	2 hollow tiles, 1 block tile, 1 cushion tile, 1 ridged tile, pebbles and driftwood.	63 375
C Sensory 2 kit	+ 12 months	3 cushioned tiles, 1 block tile and 1 ridged tile.	63 376

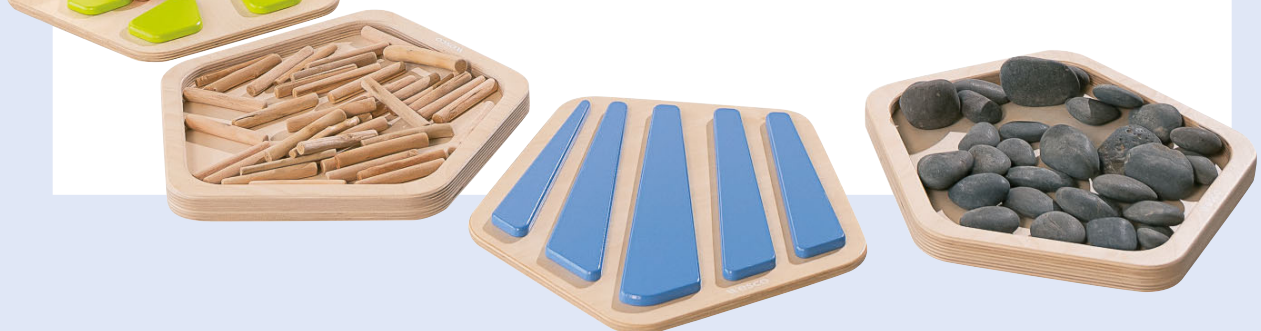



wesco
design

Phthalate-free.
Free of azo dyes.

INCLUSIVE solutions

Tactile products sharpen sensations for sight-impaired children or those with reduced feeling in their fingers.

SENSORY TINY TOT range

1 to 3 years
for use under adult supervision



SENSORY Tiles By walking barefoot on the sensory tiles or touching them with their little hands, children discover new sensations of varying intensity depending on the textures. Consists of: 1 foam tile and 1 removable cover. Side: 19" - th: 1/2". Made from VARIED FABRIC and VINYL FABRIC. Washable at 86 °F (removable cover). Indoor use. Fitted with an anti-slip base.

D Silky	63 098	set
E Soft	63 121	set
F Graphic	63 122	set
G Shiny	63 123	set
H Surface non-slip	63 124	set
I Smooth	63 125	set

SENSORY REPLACEMENT COVER	
62 474	each
62 475	each
62 476	each
62 477	each
62 478	each
62 479	each

Tile SENSORY MAXI PACK	6 foam tiles and 6 removable covers.	62 487	set
-------------------------------	--------------------------------------	--------	-----

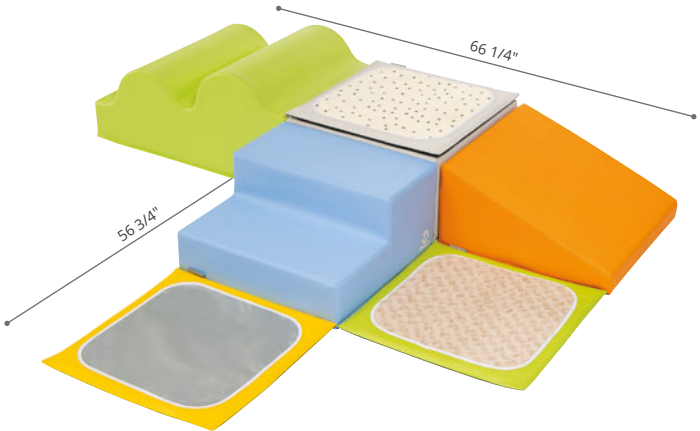

Sensory Awakening Tiny Tot module kit
Consists of: 1 large wave, 1 half-cube, 1 trapezium, 1 two step and 3 sensory tiles. Ground space: L: 66 1/4" - W: 56 3/4". Made from VARIED FABRIC and VINYL FABRIC. washable at 86 °F (removable cover). Indoor use. Fitted with an anti-slip base.

63 292 set



wesco
design
MADE IN FRANCE



A + 12 months
Manu THE BALANCING TURTLE It will keep children company during hours of fun and games: climbing, balancing, sitting, standing and more. On its back, it transforms into a rotating marble set. L: 23 1/2" - W: 21 3/4" - H: 7 3/4". Made from thick POLYETHYLENE. washable with a sponge. For indoor and outdoor use. Supplied without accessories.

62 462 each

Practise agility and patience

100% recyclable.

B + 12 months
BALANCE MUSHROOM Inspired by the classic leapfrog game, this little balance mushroom can be used alone or with others, indoors or outdoors. Upgradeable, its height is easily adjustable once the difficulty level is mastered! Choice of hat colours. Hat Ø: 15" - Height adjustable from 13" to 15 1/4". Made from thick POLYETHYLENE. washable soapy water. Choice of colours: WHITE (001) - BLUE (002) - LIGHT GREEN (037)

64 918 each



Scan the QR Code to view this product in 360° and augmented reality in your room!

wesco
design
MADE IN FRANCE

Softness made light!

+ **Safety:** This product is mains rechargeable for a battery life of over 8 hours.
Convenient use: Remote control supplied to change the colour, speed (continuous, flashing, increasing intensity, etc.) and intensity of the light.

+ 3 years
Made from thick POLYETHYLENE. Washable with a sponge. For indoor and outdoor use. Comes with a rechargeable LED light device.

		each
C	Roby the LIGHT-UP CAT L: 13 1/2" - W: 13 1/2" - H: 17 3/4"	64 924
D	Manu LIGHT-UP TORTOISE L: 23 1/2" - W: 21 3/4" - H: 7 3/4"	62 463
E	LIGHT-UP MUSHROOM Ø of the cap: 15" - Height adjustable from 13" to 15 1/4".	64 919
F	LIGHT-UP CUBE Side: 12 1/2".	64 979
G	LIGHT-UP PEBBLE Ø 14 1/2" - H: 7 3/4".	64 980



Scan the QR Code to view this product in 360° and augmented reality in your room!



Lightweight: 11,0 lbs
Easy to move with its built-in handle
Monobloc construction for greater durability
Stackable in piles of 3
Easy care: completely sponge-washable
Non-slip pads



100% recyclable.

wesco design
3 YEAR GUARANTEE
MADE IN FRANCE

Comfort solution

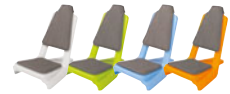

Comfort ADULT RECLINER Consists of: 1 adult recliner, 1 cushion and 1 comfort backrest. Weight: 11lbs - L: 29 1/2" - W: 22 1/2" - H: 30". Made from thick POLYETHYLENE (recliner) and VINYL FABRIC (cushion and backrest). washable with water. Indoor use. Equipped with non-slip pads. Choice of colours: GREEN/GREY (185) - BLUE/GREY (183) - ORANGE/GREY (184) - WHITE/GREY (182)

61 243

set



COMFORT ACCESSORY For adult recliners Comfortable and stable, this recliner will give you good support every day. Weight: 11lbs - L: 29 1/2" - W: 22 1/2" - H: 30". Made from thick POLYETHYLENE. washable with a sponge. For indoor and outdoor use. Choice of colours: WHITE (001) - LIGHT BLUE (057) - LIGHT GREEN (037) - LIGHT ORANGE (164)

55 981

each

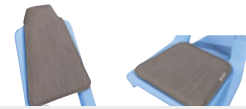

COMFORT ACCESSORY For adult recliners Weight: 11lbs - L: 29 1/2" - W: 22 1/2" - H: 30". Made from thick POLYETHYLENE. Washable with a sponge. Indoor use. Equipped with non-slip pads.

Backrest L: 21 1/4" - W: 16 1/2" - th: 3/4"

59 348

each

Cushion L: 17 3/4" - W: 15" - th: 3/4"

59 347

each

wesco design
2 YEAR GUARANTEE
MADE IN CANADA



Scan the QR Code to view this product in 360° and augmented reality in your room!



Saves space: the hut can be dismantled and stored flat!
Secure: Foam walls to absorb shocks.
Hygienic: Covered with coated fabric for easy cleaning.

Ideal for flexible classrooms



+ 18 months

Basic FLOOR SEAT This chair invites children and adults to sit comfortably on the floor for individual and group work. Its practical vinyl fabric cover is surface washable to eliminate pen or marker stains in a flash. H: 17" - Seat width: 15 3/4" - Seat H: 4". Made from VINYL COVERS. washable using a soft cloth in cold soapy water. Fitted with an anti-slip base. Choice of colours: GREEN/LIGHT GREEN (169) - BLUE/LIGHT BLUE (218) - LIGHT GREY / IVORY (181) - ORANGE/LIGHT ORANGE (220)

59 589

each

+ 18 months

Softy HUT Enjoy hours of play with the Softy HUT designed for services with limited space. This hut has been designed in foam with wide walls to absorb shocks and noises. This hut also offers a good place to calm down when the child is restless. Consists of: 4 walls with a thickness of 2 3/4", a 1 1/2" thick floor mat and a roof covered in coated fabric. H: 47 1/4" - L: 47 1/4" - W: 47 1/4". Made from FOAM and VINYL COVERS. washable : disinfectant on the surface. Indoor use. Delivered flat-packed, do-it-yourself installation. Choice of colours: LIGHT GREEN (037) - BLUE/LIGHT BLUE (218) - ORANGE/LIGHT ORANGE (220)

56 158

each



wesco
design

2 YEAR GUARANTEE

MADE IN CANADA

Complies with standard EN 1021-1 and 2: flammability of filled furnishings

Phthalate-free.

BASIC home

Quality at a *great price!*

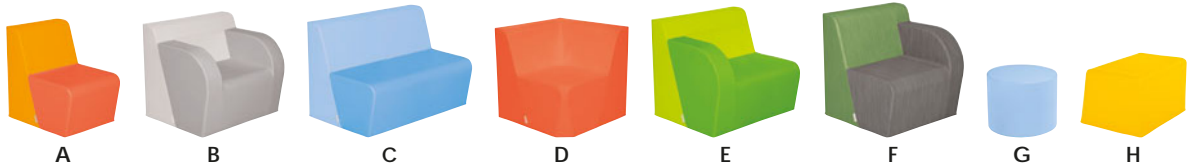





The Basic adult range has seen its lines redesigned to match the child version. Create an inviting space for kids and adults! Made from 1.5 lbs/ft3 high-density FOAM covered in VINYL FABRIC. Washable using a soft cloth in cold soapy water. Choice of colours: WHITE (001) - LIGHT BLUE (057) - BLUE (214) - TEAL (223) - LICHEN (122) - GREEN (008) - LIGHT GREEN (037) - YELLOW (014) - LIGHT ORANGE (215) - ORANGE (216) - RED (217) - SAND (135) - IVORY (138) - LIGHT GREY (180) - GREEN/LIGHT GREEN (169) - BLUE/LIGHT BLUE (218) - ORANGE/LIGHT ORANGE (220)

A Basic HEATER	L: 21 3/4" - W: 28 3/4" - H: 29 1/2" - Seat D: 17 3/4"	56 456	each
B Basic CHAIR WITH 2 ARMRESTS	L: 33 1/2" - W: 28 3/4" - H: 29 1/2" - Seat D: 17 3/4"	56 457	each
C Basic BENCH SEAT	L: 43 1/4" - W: 28 3/4" - H: 29 1/2" - Seat D: 17 3/4"	56 458	each
D Basic LOW CORNER CHAIR	L: 30" - W: 30" - H: 29 1/2" - Seat D: 17 3/4"	56 459	each
E Basic RIGHT ARMCHAIR	L: 29 1/2" - W: 27 1/2" - H: 29 1/2" - Seat D: 17 3/4"	56 460	each
F Basic LEFT ARMCHAIR	L: 29 1/2" - W: 27 1/2" - H: 29 1/2" - Seat D: 17 3/4"	56 461	each

Choice of colours: WHITE (001) - LIGHT BLUE (057) - BLUE (214) - TEAL (223) - LICHEN (122) - FABRIC EFFECT GREEN (191) - GREEN (008) - LIGHT GREEN (037) - YELLOW (014) - LIGHT ORANGE (215) - ORANGE (216) - RED (217) - SAND (135) - IVORY (138) - LIGHT GREY (180) - FABRIC EFFECT GREY (193)

G Basic ROUND POUFFE	Ø 19 3/4" - H: 15 3/4"	56 462	each
H Basic SQUARE POUFFE	L: 21 3/4" - W: 20" - H: 15 3/4"	56 463	each

 <p>Basic LOW CHAIR AND FOOTREST Consists of: 1 low chair and 1 square pouffe.</p> <p>56 499 set</p>	 <p>Basic 2 SEATER SOFA Consists of: 1 right armchair and 1 left armchair.</p> <p>56 502 set</p>	 <p>Basic 4 SEATER SOFA Consists of: 1 right armchair, one bench and 1 left armchair.</p> <p>56 505 set</p>	 <p>Basic CORNER SOFA Consists of: 1 right armchair, 2 low chairs, 1 corner low chair and 1 left armchair.</p> <p>56 507 set</p>
--	--	--	--



- +** **Comfortable and hard-wearing:** 1,5 lbs/ft³ high-density foam interior (does not sag over time) Frame and seat reinforced with metal
- Safe:** anti-fall system, made entirely from foam to prevent injury
- Hygienic:** the vinyl fabric is easy to clean with a cloth or soft sponge and cold soapy water

Seat height
15 3/4"
adult size.



Tilting movement with no risk of falling. Fabric and foam, safe for hands.

KIA reception area

Relaxation through *movement!*

Create an original and relaxing reception area with the Kia rocking chair. It's safe and users can rock with confidence.

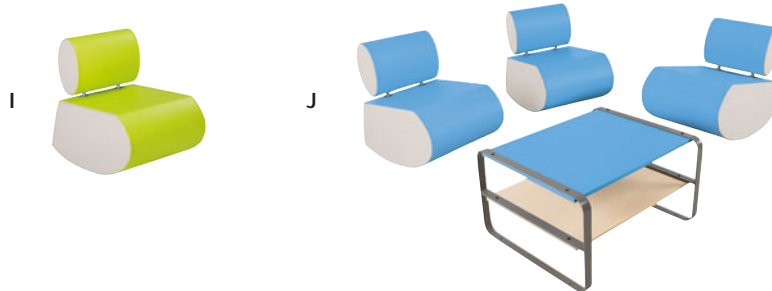

Kia SEAT Made from High-density FOAM covered with VINYL FABRIC (seat) and EPOXY finished METAL (frame).

I	ROCKING CHAIR	L: 27 1/2" - W: 23 1/2" - H: 29 1/2" - Seat height: 15 3/4".	54 869	each
J	Kia RECEPTION KIT	Rocking chair: L: 27 1/2" - W: 23 1/2" - H: 29 1/2". Coffee table: L: 31 1/2" - W: 27 1/2" - H: 18 1/4".	54 874	set

ÎLO Easels

wesco
design

3 YEAR GUARANTEE

Comes assembled.

This attractive Îlo easel is available in 2 and 4 place versions to suit your space. It can hold brushes and markers on the ledge and has metal plates to attach drawings using magnets.

- +** **Sturdy:** made of thick plastic
- Safe:** all edges are rounded
- Fully washable with water and a sponge
- Additional storage** on the 4-sided easel

 **100% recyclable.**



Metal plate for attaching drawings with magnets



Stackable



+ 2 years
ÎLO EASEL Made from thick POLYETHYLENE. For indoor and outdoor use. Comes assembled.
 Choice of colours: BLUE (002) - LIGHT GREEN (037) - LIGHT ORANGE (164)

A 2-Place	L: 22 1/2" - W: 19 3/4" - H: 37"	54 623	each
B 4-Place	L: 27 1/2" - W: 27 1/2" - H: 37"	54 156	each





wesco
design
Phthalate-free.



Smocks and protective gear

+ **Synthetic bias finish**
Adjustable neckline and hanging loop
Smocks with elasticated sleeves

Name tag pocket
Fastens with adjustable
Velcro strips at the back

Flexible fabric: extra-comfortable

+ **Waterproof**
Washable at 86°F



Made from 100% POLYAMIDE FABRIC. Washable at 86 °F. Fitted with a name tag pocket and a hanging loop. Choice of colours: BLUE (002) - GREEN (008) - YELLOW (014) - RED (011)

	Height 32"/38" 18 to 36 months	Height 39"/46" 4 to 6 years	Height 45"/55" 7 to 10 years
CHILD'S APRON	39 420	39 421	39 422
CHILD'S SMOCK	39 423	39 424	39 425

Vinyl cover: Guaranteed protection



Made from VINYL COVERS. Washable with a sponge. Has a hanging loop. Choice of colours: BLUE (002) - GREEN (008) - ORANGE (007)

	Height 32"/38" 18 to 36 months	Height 39"/46" 4 to 6 years	Height 45"/55" 7 to 10 years
HIGHLY PROTECTIVE CHILD'S APRON	39 426	39 421	39 428
HIGH PROTECTION SMOCK	39 429	39 431	39 432
HIGH PROTECTION LONG SMOCK	40 882	40 883	

PAINTBOARD 1st prize Made from POLYESTER. each

C 2-3 years	GREEN (008)	65 832
D 3-5 years	RED (011)	65 831
E 6-8 years	BLUE (002)	65 830

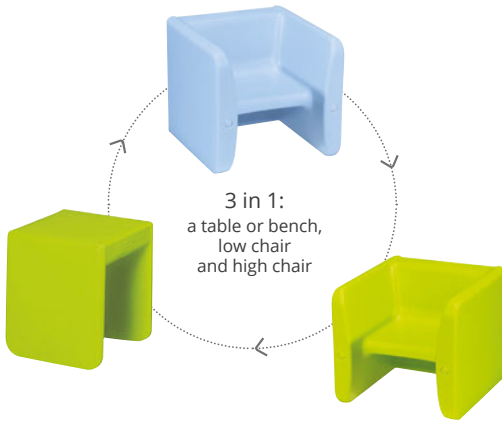

PILOUFACE

tables and chairs

Reversible

for 2 seat heights

and 1 table

- +** **Sturdy:** made from thick plastic
- Hygienic:** easy to clean and disinfect
- Safe:** all edges are rounded
- Stackable for easy storage
- Can be used indoors and outdoors

100% recyclable.



wesco
design

3 YEAR GUARANTEE

MADE IN FRANCE

Phthalate-free.

S00 to S0

for children under 35 1/2" tall.



Choice of colours:
LIGHT BLUE (057) -
LIGHT GREEN (037)

Pilouface
ARMCHAIR/TABLE

W: 14 1/2" - D: 15 3/4" - H: 13 3/4" -
Seat H: 7" or 8 1/4".

04 710
each



Choice of colours:
BLUE (002) - GREEN (008)

Pilouface
BENCH SEAT/TABLE

W: 29 1/4" - D: 15 3/4" - H: 13 3/4" -
Seat H: 7" or 8 1/4".

11 472
each



Choice of colours:
LIGHT BLUE (057) -
LIGHT GREEN (037)

Pilouface
MAXI ARMCHAIR

W: 18 1/2" - D: 19 3/4" - H: 20 1/4" -
Seat H: 10 1/4" or 12 1/4".

20 031
each



Choice of colours:
BLEU (002) - VERT (008)

Pilouface
MAXI BENCH SEAT

W: 34 3/4" - D: 19 3/4" - H: 20 1/4" -
Seat H: 10 1/4" or 12 1/4".

20 032
each



**Size 1
to Size 2**
for children
from 2 to 7 years
(36 1/2" to
47 3/4" tall).

wesco
design
3 YEAR GUARANTEE

Complies with standard
D60-300
Phthalate-free.

FLORA tables and stools The aesthetic touch!



- Sturdy:** made of thick plastic
- Hygienic:** can be cleaned with a sponge and disinfected
- Safe:** all edges are rounded
- Stackable:** all sizes available



100% recyclable.

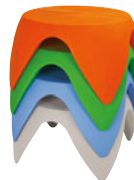

A

Flora STOOL Made from thick POLYETHYLENE. Washable with a sponge. For indoor and outdoor use. Choice of colours: PURPLE (034) - LIGHT BLUE (057) - LIGHT GREEN (037) - LIGHT ORANGE (164)

T1 Ø 12 1/2" - H: 10 1/4".

44 872 each

T2 Ø 12 3/4" - H: 12 1/4".

44 873 each



B

Flora TABLE Ø 31" - H: 18 1/2". Made from thick POLYETHYLENE, washable with a sponge. For indoor and outdoor use. Choice of colours: BLUE (002) - GREEN (008) - ORANGE (007) - GREY (006)

44 874 each



Flora LIVING ROOM Size 1 to Size 2 for children from 2 to 7 years (36 1/2" to 47 3/4" tall). Made from thick POLYETHYLENE. Washable with a sponge. For indoor and outdoor use. Choice of colours: GREEN/LIGHT GREEN (169) - BLUE/LIGHT BLUE (059) - ORANGE/LIGHT ORANGE (168)

2 to 5 years

Size 1 Consists of: 1 table and 4 Size 1 stools

45 133 set

5 to 7 years

Size 2 Consists of: 1 table and 4 Size 2 stools

45 132 set

TADAM

Storage trays

Quickly set up a meeting area while enjoying clever storage space! Once the activity is over, the trays slide under the seats for a readily optimised space.

- +** **Hygienic:** can be easily cleaned and disinfected
- Durable:** made from thick plastic
- Safe:** all edges are rounded
- Practical:** top and bottom handles for easy grasping
- Clever:** all containers can be stacked together

 100% recyclable.



Slide the trays under the seats and you're done!



 **wesco**
design
GUARANTEE 3-YEARS
except accessories
Phthalate-free.



Tadam TRAY Made from thick POLYETHYLENE. For indoor and outdoor use. Choice of colours: WHITE (001) - LIGHT BLUE (057) - LIGHT GREEN (037) - LIGHT ORANGE (164)

SINGLE Side: 12 1/2" - H: 12 1/2" - Capacity: 4,75 gal.
56 132 each

Double L: 25 1/4" - W: 12 1/2" - H: 12 1/2" - Capacity: 10,30 gal.
56 133 each



Tadam BENCH Made from thick POLYETHYLENE. For indoor and outdoor use. Choice of colours: LIGHT BLUE (057) - LIGHT GREEN (037) - LIGHT ORANGE (164)

Double L: 28 1/2" - H: 15 3/4" - D: 16".

56 134 each

Quadruple Side: 28 1/2" - H: 15 3/4".

56 135 each



Tadam DOUBLE CUSHION
L: 25 1/4" - W: 12 1/2".

56 136 each

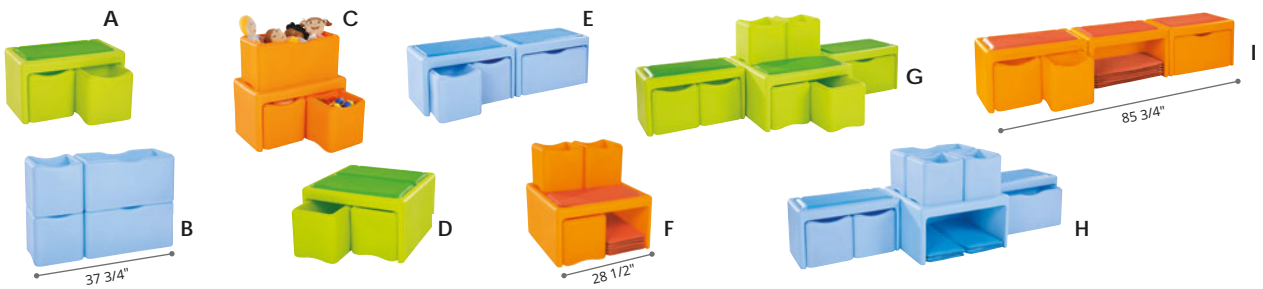

Made from Thick POLYETHYLENE and VINYL FABRIC (cushion). Choice of colours: BLUE (002) - LIGHT GREEN (037) - ORANGE (007)



set

A	Tadam BENCH KIT	2 single trays, 1 x 2-seater bench and 1 cushion.	L: 28 1/2" - W: 16" - H: 15 3/4".	56 146
B	Tadam WALL KIT	2 single trays, 2 double trays.	L: 37 3/4" - W: 16" - H: 24 3/4".	56 147
C	Tadam TOWER KIT	2 single trays, 1 double tray and 1 x 2-seater bench.	L: 28 1/2" - W: 16" - H: 28".	56 148
D	Tadam PODIUM KIT	2 double trays, 1 x 4-seater bench and 2 cushions.	L: 28 1/2" - W: 28 1/2" - H: 15 3/4".	56 149
E	Tadam DUAL BENCH KIT	2 single trays, 1 double tray, 2 x 2-seater benches and 2 cushions.	L: 57" - W: 16" - H: 15 3/4".	56 151
F	Tadam CUBE KIT	2 single trays, 1 double tray, 1 x 4-seater bench and 6 cushions.	L: 28 1/2" - W: 28 1/2" - H: 28".	56 152
G	Tadam GROUP KIT	4 single trays, 3 double trays, 2 x 2-seater benches, 1 x 4-seater bench and 3 cushions.	L: 85 3/4" - W: 28 1/2" - H: 28".	56 153
H	Tadam BUNDLING KIT	4 single trays, 2 double trays, 2 x 2-seater benches, 1 x 4-seater bench and 8 cushions.	L: 85 3/4" - W: 28 1/2" - H: 28".	56 154
I	Tadam TRIPLE BENCH KIT	2 single trays, 1 double tray, 3 x 2-seater benches and 9 cushions.	L: 85 3/4" - W: 16" - H: 15 3/4".	56 155

Comfortable size!

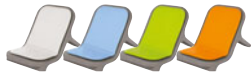

+ 2 years
CHILD'S MONOBLOC DECKCHAIR with comfort cushion Consists of: 1 x grey monobloc deckchair and 1 colour cushion. L: 28 1/4" - W: 17 3/4" - H: 17". Made from FOAM/VINYL COVERS (cushion) and thick POLYETHYLENE. Washable with a sponge. Indoor use. Choice of colours: WHITE (001) - LIGHT BLUE (057) - LIGHT GREEN (037) - LIGHT ORANGE (164)

45 218 set



+ 2 years
MONOBLOC DECKCHAIR L: 28 1/4" - W: 17 3/4" - H: 17 1/4". Made from thick POLYETHYLENE. washable with a sponge. For indoor and outdoor use. Choice of colours: LIGHT BLUE (057) - LIGHT GREEN (037) - LIGHT ORANGE (164) - GREY (006)

44 645 each



COMFORT CUSHION for stackable child recliner L: 28 1/4" - W: 17 3/4" - H: 17 1/4". Made from VINYL COVERS. washable with water. Indoor use. Choice of colours: WHITE (001) - LIGHT BLUE (057) - LIGHT ORANGE (164) - LIGHT GREEN (037)

45 217 each



Ultra-light: 8,2 lbs
Stable Stackable in piles of 3
Easy care: completely sponge-washable.



100% recyclable.



From birth
Gaya PODIUM Children can use the Gaya Podium however they like: they can sit on it, cross it or use it as a table alone or with 2, 3 or more friends. It creates a free space and a quirky world. L: 58 1/4" - W: 54" - H: 17 3/4". Weight: 77,2 lbs. Made from thick POLYETHYLENE. washable with water. Indoor use. Colours LIGHT GREEN (037)

51 880 each



1 YEAR GUARANTEE

Free of azo dyes.

Horseshoe cushion for babies

The first ultra-soft seats for babies!

- +** Fabrics guaranteed **free of azo dyes**.
- Comforting:** holds the infant securely and gives a sense of safety.
- Practical:** easily transportable.

A 4 to 9 months
HORSESHOE CUSHION Made from 100% POLYESTER VELVET. Washable at 86 °F. Choice of colours: GREEN/LIGHT GREEN (169) - BLUE/LIGHT BLUE (059)

Small size Ext: W: 20 3/4" - D: 16 1/2" - th: 6". Int: W: 7" - D: 5 1/2".
57 239 each

Large size Ext: W: 23 1/2" - D: 20 3/4" - th: 5 1/2". Int: W: 10 3/4" - D: 9".
57 242 each

B 6 to 9 months
BABY CHAIR The back offers more support and the securely sewn base fabric of the seat holds the infant and prevents slipping out. Backrest: H: 11 3/4" - Ext.: W: 24 3/4" - D: 17 3/4". Int: W: 7" - D: 9 1/2". Made from 100% POLYESTER VELVET. washable at 86 °F. Choice of colours: GREEN/LIGHT GREEN (169) - BLUE/LIGHT BLUE (059)
57 243 each

C 6 to 9 months
SIT-U-UP This baby support cushion supports securely so that the baby feels safe. The vinyl fabric can simply be wiped clean with a sponge for optimal hygiene. H: 5" - Ø 19 3/4". Made from POLYETHER FOAM, density 1,5 lbs/ft3, covered with VINYL FABRIC. washable using a soft cloth in cold soapy water. Fitted with an anti-slip base. Colours LIGHT BLUE / IVORY (186)
57 288 each

5-point removable harness.

wesco design

2-in-1, convertible!

- +** Hygienic thanks to its easy to clean vinyl fabric. The high-density foam does not sag over time.
- Convertible from age 0 to 3 years with 2 positions:**
 - reclined and bucket position for babies up to 9 months (or 19,8 lbs)
 - upright position with a removable harness for older children up to 3 years

From birth
Origami BABY BOUNCER/CHAIR Space in Baby position: L: 28 3/4" - W: 16 1/2". Made from Cotton-lined VINYL FABRIC and 1,5 lbs/ft3 POLYETHER FOAM. washable with water. Choice of colours: LIGHT BLUE (057) - LIGHT GREEN (037) - LIGHT GREY (180)
56 018 each



4 to 9 months
BABY SUPPORT CUSHION MAT Made from 100% POLYESTER VELVET FABRIC padded with POLYESTER fibres. Washable at 86 °F.

D Nomad	Mat: L: 35 1/2" - W: 17 3/4". Baby support: D: 14 1/2" - W: 16 1/2" - th: 4 3/4".		57 244
E Group	Mat: Ø 55". Baby support: D: 14 1/2" - W: 16 1/2" - th: 4 3/4".		57 245
F Caterpillar	Mat L: 35 1/2" - W: 30 1/4". Baby support: D: 15 3/4" - W: 20 1/2" - th: 4 3/4".		44 243

- +** **Removable cover:** with zip closure
- Strong:** support cushion securely stitched to mat
- Safe:** no risk of slipping
- Comfortable:** soft mat



wesco
design

2 YEAR GUARANTEE

MADE IN CANADA

Complies with standard
EN 1021-1 and 2:
flammability of filled
furnishings

Phthalate-free.

BABY SEAT activity areas

From birth
for use under adult supervision

Our "Babyseats" can be used singly or together to form areas for playing, reading or resting.



Easy to arrange:

each Babyseat has a common 29 1/2" side
and a self-adhering band on the edge

Comfort and strength:

1,5 lbs/ft³ high-density foam interior
(does not sag over time)

Hygienic:

the vinyl fabric is easy to clean with a cloth or soft sponge
and cold soapy water

With edges for greater comfort!



A



B



C



D

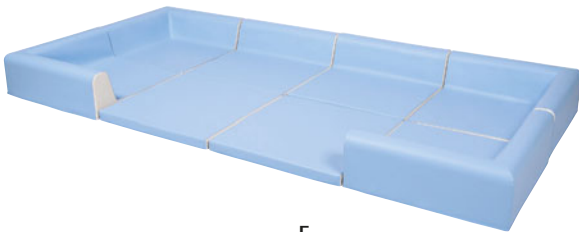

E



F

From birth Made from VINYL COVERS. Washable using a soft cloth in cold soapy water. Fitted with an anti-slip base. Choice of colours: LIGHT BLUE / IVORY (186) - LIGHT GREEN / IVORY (187) - YELLOW/IVORY (209)

A	Little Nest Babyseat KIT	3 triangular Baby seats	Floor space: 29 1/2 x 59".	59 214
B	Nest Babyseat KIT	6 Babyseats, including 5 triangles with backrest and 1 triangular mat.	Floor space: Ø 59".	39 828
C	Ring Babyseat KIT	8 Babyseats, including 6 triangles, 1 square and 1 square mat.	Floor space: 59 x 80 3/4".	39 831
D	Oasis Babyseat KIT	10 Babyseats, including 6 triangles, 2 squares and 2 square mats.	Floor space: 59 x 110 1/4".	39 833
E	Rest area Babyseat KIT	8 Babyseats, including 4 corner squares, 2 squares and 2 mats.	Floor space: 59" x 118".	45 779
F	Square Babyseat KIT	4 Baby seat square corner mats, 250 transparent balls.	H: 10 1/4". Ground space: 59 x 59".	43 168
		4 Baby seat square corner mats.	H: 10 1/4". Floor space: 59 x 59".	48 419



TRIANGULAR Baby seat MAT
L: 29 1/2" - W: 25 1/2" - th: 2 1/4".
Choice of colours: LIGHT BLUE / IVORY (186) - LIGHT GREEN / IVORY (187) - YELLOW/IVORY (209)

05 173 each



SQUARE Baby seat MAT
L: 29 1/2" - W: 29 1/2" - th: 2 1/4".
Choice of colours: LIGHT BLUE / IVORY (186) - LIGHT GREEN / IVORY (187) - YELLOW/IVORY (209)

05 174 each



TRIANGULAR Baby seat WITH BACKREST
L: 29 1/2" - W: 25 1/2" - H: 9 3/4" - th: 2 1/4". Choice of colours: LIGHT BLUE / IVORY (186) - LIGHT GREEN / IVORY (187) - YELLOW/IVORY (209)

04 576 each



SQUARE Baby seat WITH BACKREST
L: 29 1/2" - W: 29 1/2" - H: 9 3/4" - th: 2 1/4". Choice of colours: LIGHT BLUE / IVORY (186) - LIGHT GREEN / IVORY (187) - YELLOW/IVORY (209)

05 172 each

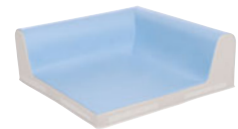

SQUARE Baby seat CORNER WITH BACKREST
L: 29 1/2" - W: 29 1/2" - H: 9 3/4" - th: 2 1/4". Choice of colours: WHITE (001) - LIGHT BLUE / IVORY (186) - LIGHT GREEN / IVORY (187) - YELLOW/IVORY (209)

42 972 each



WESCO
design

Complies with standard
EN 1021-1 : flammability
of filled furnishings



C

SEATY range

Like sitting on a cloud...

Highly resistant waterproof fabric



Exceptional comfort: microbeads
that fit snugly around all body shapes
Easy care: wash with a sponge
Practical: handle for easy carry

A



B



F



D



E



G



seat height:
15 3/4"

H



+ 18 months

Seaty CUSHION Washable at 86 °F (removable cover). For indoor and outdoor use. Choice of colours: LIGHT BLUE (057) - LIGHT GREEN (037) - ORANGE (007)



		each	REPLACEMENT COVER each
A Cube	L: 15 3/4" - W: 15 3/4" - H: 15 3/4".	53 936	53 886
B Pyramid	L: 35 1/2" - W: 35 1/2" - H: 30 3/4".	53 935	53 884
C Kid	L: 51 1/4" - W: 35 1/2" - H: 11 3/4".	53 934	53 883
D Relax	L: 78 3/4" - W: 27 1/2" - H: 11 3/4".	53 922	53 882
E Maxi Relax	L: 98 1/2" - W: 35 1/2" - H: 11 3/4".	58 386	57 292
F Large	L: 63" - W: 47 1/4" - H: 11 3/4".	53 919	53 881
G LOW CHAIR	L: 39 1/4" - W: 27 1/2" - H: 35 1/2".	58 394	58 391
H BENCH	L: 55" - W: 39 1/4" - H: 35 1/2".	58 395	58 392



Seat cushions



I + 12 months
NIDOO SEAT Our must-have Nidoo comes in an ultra-soft, easy care fabric for even greater comfort. Filled with microbeads, the Nidoo fits snugly around the child's body, offering excellent support with no risk of toppling over. H. max: 15 3/4" - Ø 23 1/2". Made from 100% POLYESTER FABRIC (255 g/m²) filled with POLYSTYRENE MICROBEADS, washable at 86 °F (removable cover). Choice of colours: LIGHT BLUE (057) - LIGHT GREEN (037) - ORANGE (007)

59 494 each

REPLACEMENT COVER For Nidoo seats
 59 492 each



J + 18 months
SEAT CUSHION Soft fabric with a pleasant feel, guaranteed free from azo dyes. Invisible fastening. L: 21 3/4" - W: 21 3/4" - H: 19 3/4". Made from 65% POLYESTER - 35% COTTON filled with POLYSTYRENE beads, washable at 86 °F (removable cover). Choice of colours: BLUE (002) - GREEN (008) - ORANGE (007)

33 903 each

HOUSSE DE RECHANGE For seat cushions
 33 902 each

K + 18 months
BEANBAG CHAIR Comfortable and fun, this beanbag shapes itself to your body for a better seating position. L: 21 3/4" - W: 21 3/4" - H: 33 1/2". Made from JERSEY-lined COATED FABRIC, filled with POLYSTYRENE MICROBEADS, washable using a soft cloth in cold soapy water. Choice of colours: WHITE (001) - LIGHT BLUE / IVORY (186) - LIGHT GREEN / IVORY (187) - LIGHT ORANGE/IVORY (222)

37 674 each

L + 18 months
VERSATILE LEAF CUSHION Whether sitting or lying down, children will always be comfortable! This ultra-soft cushion simply invites children to relax! L: 31 1/2" - W: 26" - H: 10 and 7 3/4". Made from 65% POLYESTER, 35% COTTON padded with POLYESTER fibres, washable at 86 °F (removable cover). Colours GREEN/LIGHT GREEN (169)

57 287 each

2 YEAR GUARANTEE

Complies with standard EN 1021-1 and 2: flammability of filled furnishings
 Phthalate-free.

Ultra -soft!

From 18 months or 19,8 lbs!





2 YEAR GUARANTEE

MADE IN CANADA

Complies with standard EN 1021-1 and 2: flammability of filled furnishings

Phthalate-free.

Pouffes

Enticing and cosy, our decorative pouffes and discs create a space for relaxation and reading in the blink of an eye! Easy to store in our mobile furniture!

- +** **Screen-printed decor for greater durability.**
- Comfort and strength:** 1,5 lbs/ft³ high density foam interior (does not sag over time).
- Easy to clean:** the vinyl fabric can be cleaned with a cloth or soft sponge and cold soapy water or our product.



Seat height: 2 1/4"



NOMAD POUFFE

Choice of colours:
LIGHT BLUE (057) - TEAL (223) - LICHEN (122) - LIGHT GREEN (037)

L: 19 3/4" - W: 16 1/2" - H: 2 1/4".

68 217

4 NOMAD POUFFES

68 218 pack of 4



DISC

Choice of colours:
WHITE (001) - LIGHT BLUE (057) - LIGHT GREEN (037) - ORANGE (216) - SAND (135)

Ø 13 3/4" - H: 2 3/4".

00 864

Seat height: 2 3/4"

CITRUS DISC



Lime

GREEN/LIGHT GREEN (169)
Ø 13 3/4" - H: 2 3/4".
59 495



Lemon

YELLOW (014)
Ø 13 3/4" - H: 2 3/4".
59 496



Orange

LIGHT ORANGE (215)
Ø 13 3/4" - H: 2 3/4".
59 497

2 3/4" CITRUS DISC MAXI PACK

59 536
pack of 3

Seat height: 7 3/4"

DECORATIVE SCHOOL POUFFE



The alphabet
LIGHT BLUE (057)
Ø 13 3/4" - H: 7 3/4".
59 499



Numbers
YELLOW (014)
Ø 13 3/4" - H: 7 3/4".
59 522



Pencils
LIGHT GREEN (037)
Ø 13 3/4" - H: 7 3/4".
59 523



Panda
LIGHT GREEN (037)
Ø 13 3/4" - H: 7 3/4".
59 524



Red panda
ORANGE (216)
Ø 13 3/4" - H: 7 3/4".
59 525



Lion
YELLOW (014)
Ø 13 3/4" - H: 7 3/4".
59 526

SCHOOL DECORATIVE POUFFE MAXI PACK
59 538
pack of 3

WILD ANIMALS DECORATIVE POUFFE MAXI PACK
59 539
pack of 3



GRAPHIC DECORATIVE POUFFE

Choice of colours:
LIGHT BLUE (057) - LIGHT GREEN (037) - YELLOW (014)
Ø 13 3/4" - H: 7 3/4".
59 498

GRAPHIC DECORATIVE POUFFE MAXI PACK
59 537
pack of 3



Seat height:
9 1/2"



Cube MINI POUFFE

Choice of colours: DARK GREEN/
LIGHT GREEN (025) - BLUE/LIGHT BLUE
(218) - LIGHT GREY / IVORY (181)
- ORANGE/LIGHT ORANGE (220)



56 531
L: 9 1/2" - W: 9 1/2" - H: 9 1/2"

Seat height:
10 15/64"



Ding Dong POUFFE / BENCH

Choice of colours: BLUE (214) - LIGHT
GREEN (037) - ORANGE (216)



58 269
L: 25 1/2" - D: 11 3/4" - H: 10 1/4"



Ding Dong CUSHION

Choice of colours: BLUE (214) - LIGHT
GREEN (037) - ORANGE (216)



58 271
L: 25 1/2" - D: 11 3/4" - th: 3/4"



DISC Ø 13 3/4" - th: 1/2". Made from
POLYETHER foam coated with VINYL
COVERS. washable using a soft cloth
in cold soapy water. Choice of colours:
LIGHT BLUE (057) - BLUE (214) - GREEN
(008) - LIGHT GREEN (037) - YELLOW
(014) - LIGHT ORANGE (215) - ORANGE
(216) - RED (217) - IVORY (138)

50 136 each

**MAXI PACK OF 9 CUSHION
PADS Assorted colours**

50 137 pack of 9



wesco
design
2 YEAR GUARANTEE

REZISTATOO Mats

Giant!
ULTRA durable!

- +** Withstands intensive use and washing
- 100% 2,100 g/m² polyamide**
- Anti-pilling
- Ultra-robust back

Rezistatoo MAT Made from 2,100 g/m² POLYAMIDE machine sewn with back woven strong synthetic fabric. Washable with carpet shampoo.

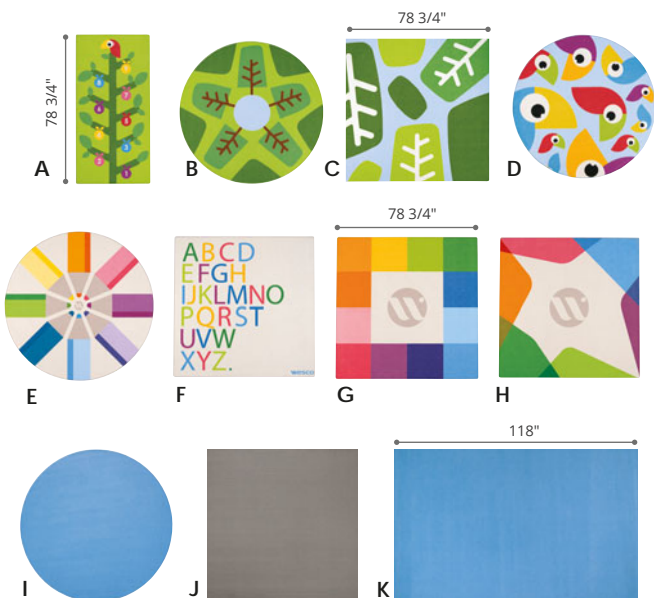

		each
A Tree	L: 78 3/4" - W: 39 1/4" - th: 1/4".	58 492
B Camp	Ø 78 3/4" - th: 1/4".	58 489
C Leaves	L: 78 3/4" - W: 78 3/4" - th: 1/4".	58 491
D Zoozios	Ø 78 3/4" - th: 1/4".	58 488
E Pencils	Ø 78 3/4" - th: 1/4".	63 322
F Alphabet	L: 78 3/4" - W: 78 3/4" - th: 1/4".	63 319
G Coloured squares	L: 78 3/4" - W: 78 3/4" - th: 1/4".	63 320
H Multicoloured	L: 78 3/4" - W: 78 3/4" - th: 1/4".	63 321

MONOCHROME Rezistatoo MAT th: 1/4". Made from 2,100 g/m² POLYAMIDE machine sewn with back woven strong synthetic fabric. Choice of colours: BLUE (002) - GREY (006)

		each
I Round	Ø 78 3/4" - th: 1/4".	51 274
J Square	L: 78 3/4" - W: 78 3/4" - th: 1/4".	51 275
K Rectangle	L: 118" - W: 78 3/4" - th: 1/4".	51 276



2 YEAR GUARANTEE

MADE IN CANADA

Complies with standard EN 1021-1 and 2: flammability of filled furnishings

Phthalate-free.



Hygienic: clean the vinyl fabric easily with a cloth or soft sponge and cold soapy water

Tough: high-density 1,5 lbs/ft3 foam interior that does not sag over time

No risk of injury: foam covered with vinyl fabric

Fitted with an anti-slip base.

BASIC recreation areas

From birth
for use under adult
supervision

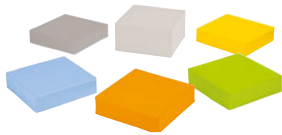

SQUARE POUFFE Reading SQUARE MODULES

Consists of: 5 square cushions height: 4 3/4", 1 square cushion height: 9 3/4".

66 677 pack of 6



SQUARE POUFFE Checkerboard corner SQUARE MODULES

Consists of: 1 Liloo container, 2 square cushions height: 9 3/4", 3 square cushions height: 4 3/4".

66 678 pack of 6



TINY TOT Module Little domino SQUARE MODULES

Consists of: 1 T podium, 2 big bricks and 4 high square pouffes. 4 3/4".

61 312 set



SQUARE POUFFE Relaxation area SQUARE MODULES

Consists of: 3 square cushions height: 9 3/4", 5 square cushions height: 4 3/4" and 4 cushions height: 2 1/4".

61 818 set



L



M



N

SQUARE POUFFE Choice of colours: WHITE (001) - LIGHT BLUE (057) - BLUE (214) - TEAL (223) - LICHEN (122) - MOSS GREEN (139) - GREEN (008) - SPRING GREEN (104) - LIGHT GREEN (037) - YELLOW (014) - LIGHT ORANGE (215) - ORANGE (216) - RED (217) - SAND (135) - IVORY (138) - LIGHT GREY (180)



each

L Basic - H: 2 1/4"

L: 19" - W: 19" - H: 2 1/4".



04 013

M Basic - H: 4 3/4"

L: 19" - W: 19" - th: 4 3/4".



04 503

N Basic - H: 9 3/4"

L: 19" - W: 19" - H: 9 3/4".



00 861

Velcro strip for easy assembly!



TRAPEZIUM POUFFE

L. ext. 47 1/4" - L. in. 30" - W: 17 1/4" - H: 9 3/4" - Depth: 15".
Choice of colours: LIGHT BLUE (057) - BLUE (214) - GREEN (008) - LIGHT GREEN (037) - LIGHT ORANGE (215) - ORANGE (216)

00 865 each



The relaxation centre TRAPEZIUM POUFFES KIT

Consists of: 2 blue pouffes, 2 green pouffes and 2 light orange pouffes.

66 679 pack of 6



The ring TRAPEZIUM POUFFE KIT

Consists of: 6 trapezium pouffes, 1 floor mat.

66 680 set



BASE MAT This mat is used as a base in the hexagon shape made with trapezium-shaped pouffes. 60 3/4 x 53 1/4" - Side 30" - Th: 3/4". Colours SAND (135)

00 186 each



BASIC range

Vibrant colours!

For a colourful ambiance!

The combination of warm shades and soothing and reassuring colours to create a universe of stimuli.



- Hygienic:** clean the vinyl fabric with a cloth or soft sponge and cold soapy water or with our cleaning product
- Durable:** high-density 1,5 lbs/ft3 foam interior that does not sag over time
- Safe:** foam covered with vinyl fabric

Choice of colours:
 WHITE (001) - IVORY (138) - YELLOW (014) - LIGHT ORANGE (215) - ORANGE (216) - RED (217) - LIGHT BLUE (057) - BLUE (214) - LIGHT GREEN (037) - GREEN (008) - LIGHT GREY (180) - ORANGE/LIGHT ORANGE (220) - BLUE/LIGHT BLUE (218) - GREEN/LIGHT GREEN (169) - LIGHT GREY/IVORY (181)



	STRAIGHT CHAIR	LOW CORNER CHAIR	TWO-SEATER BENCH	3-SEATER BENCH	4-SEATER BENCH
Seat height 6 3/4": user size - from 31 1/2".	W: 11 3/4" - H: 14 3/4" - D: 15 3/4". Seat: H: 6 3/4" - D: 9 1/2". 54 184	W: 17 3/4" - H: 14 3/4" - D: 15 3/4". Seat: H: 6 3/4" - D: 9 1/2". 54 187	W: 23 1/2" - H: 14 3/4" - D: 15 3/4". Seat: H: 6 3/4" - D: 9 1/2". 54 190	W: 35 1/2" - H: 14 3/4" - D: 15 3/4". Seat: H: 6 3/4" - D: 9 1/2". 54 193	W: 47 1/4" - H: 14 3/4" - D: 15 3/4". Seat: H: 6 3/4" - D: 9 1/2". 54 198
Seat height 9 3/4": user height 31 1/2" to 45 3/4".	W: 13 3/4" - H: 19 1/4" - D: 17 3/4". Seat: H: 9 3/4" - D: 11 3/4". 54 185	W: 19 3/4" - H: 19 1/4" - D: 17 3/4". Seat: H: 9 3/4" - D: 11 3/4". 54 188	W: 27 1/2" - H: 19 1/4" - D: 17 3/4". Seat: H: 9 3/4" - D: 11 3/4". 54 191	W: 41 1/4" - H: 19 1/4" - D: 17 3/4". Seat: H: 9 3/4" - D: 11 3/4". 54 194	W: 51 1/4" - H: 19 1/4" - D: 17 3/4". Seat: H: 9 3/4" - D: 11 3/4". 54 199
Seat height 12 1/2": user height 42 1/2" to 56".	W: 19 3/4" - H: 23 1/2" - D: 21 3/4". Seat: H: 12 1/2" - D: 13 3/4". 54 186	W: 23 3/4" - H: 23 1/2" - D: 21 3/4". Seat: H: 12 1/2" - D: 13 3/4". 54 189	W: 39 1/4" - H: 23 1/2" - D: 21 3/4". Seat: H: 12 1/2" - D: 13 3/4". 54 192	W: 51 1/4" - H: 23 1/2" - D: 21 3/4". Seat: H: 12 1/2" - D: 13 3/4". 54 196	W: 63" - H: 23 1/2" - D: 21 3/4". Seat: H: 12 1/2" - D: 13 3/4". 54 200

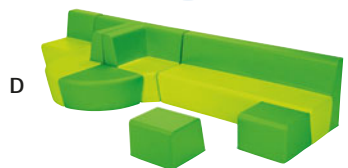
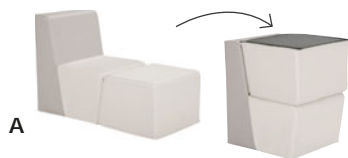

Choice of colours: GREEN/LIGHT GREEN (169) - BLUE/LIGHT BLUE (218) - LIGHT GREY / IVORY (181) - ORANGE/LIGHT ORANGE (220)

	A COMFORT LOW CHAIR Consists of: 1 straight low chair and 1 small square cushion.	B ISLAND KIT Consists of: 4 quarter circle pouffes and 2 straight low chairs.	C CORNER LIVING ROOM KIT Consists of: 1 corner armchair, 1 2-seater bench, 1 3-seater bench, 1 quarter circle pouffe and 1 round pouffe.	D LARGE LIVING ROOM KIT Consists of: 2 corner armchairs, 1 4-seater bench, 1 straight low chair, 2 quarter circle pouffes and 2 small square cushions.
	set	set	set	set
Height 6 3/4"	54 229	54 234	54 237	54 240
Height 9 3/4"	54 231	54 235	54 238	54 241
Height 1 1/2"	54 233	54 236	54 239	54 242

Choice of colours: WHITE (001) - IVORY (138) - YELLOW (014) - LIGHT ORANGE (215) - ORANGE (216) - RED (217) - LIGHT BLUE (057) - BLUE (214) - LIGHT GREEN (037) - GREEN (008) - LIGHT GREY (180)



SMALL SQUARE CUSHION

W: 11 3/4" - H: 6 3/4" - D: 10 3/4".
54 178



ROUND POUFFE

Ø 15 3/4" - H: 6 3/4".
01 794



QUADRANT POUFFE

L: 15 3/4" - H: 6 3/4".
54 181



SQUARE POUFFE

L: 15 3/4" - W: 15 3/4" - H: 6 3/4".
01 793

W: 13 3/4" - H: 9 3/4" - D: 13 1/2".
54 179

Ø 15" - H: 9 3/4".
00 860

W: 17 3/4" - H: 9 3/4".
54 182

L: 19" - W: 19" - H: 9 3/4".
00 861

W: 19 3/4" - H: 12 1/2" - D: 16".
54 180

Ø 23 1/2" - H: 12 1/2".
00 645

W: 21 3/4" - H: 12 1/2".
54 183

L: 23 1/2" - W: 23 1/2" - H: 12 1/2".
00 644



Ideal for flexible classrooms

+ 18 months
Basic FLOOR SEAT This chair invites children and adults to sit comfortably on the floor for individual and group work. Its practical comfortably on the floor for individual and group work. Its practical vinyl fabric cover is surface washable to eliminate pen or marker stains in a flash. H: 17" - Seat width: 15 3/4" - Seat H: 4". Made from VINYL COVERS, washable using a soft cloth in cold soapy water. Fitted with an anti-slip base. Choice of colours: GREEN/LIGHT GREEN (169) - BLUE/LIGHT BLUE (218) - LIGHT GREY / IVORY (181) - ORANGE/LIGHT ORANGE (220)

59 589 each

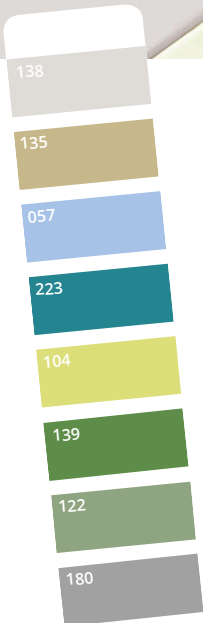

A symbol of nature, green comforts and calms the mind.

Blue, a symbol of water and sky, is known to help manage stress and anxiety.

Beige reminds us of wood and lends a warm and luminous hue.

Grey has a soothing and refreshing presence. Combined with other colours, it creates a relaxing environment.

BASIC range

Natural colours

For a soft and soothing atmosphere

Create a world of stimulation, conducive to a more relaxing experience. How? By combining our wooden furniture with our vinyl covered motor and reading units, all in soft and harmonious colours.



Hygienic: the vinyl fabric is easy to clean with a cloth or soft sponge and cold soapy water

Tough: high-density 1,5 lbs/ft³ foam interior that does not sag over time

No risk of injury: foam covered with vinyl fabric



Choice of colours:

IVORY (138) – SAND (135) – LIGHT BLUE (057) – DUCK BLUE (223) – SPRING GREEN (104) – MOSS GREEN (139) – LICHEN (122) – LIGHT GREY (180)



SMALL SQUARE CUSHION



QUADRANT POUFFE



STRAIGHT CHAIR



LOW CORNER CHAIR



TWO-SEATER BENCH

Seat height 6 3/4":
user size – from 31 1/2".

W: 11 3/4" - H: 6 3/4" -
D: 10 3/4".
54 178

L: 15 3/4" -
H: 6 3/4".
54 181

W: 11 3/4" - H: 14 3/4" -
D: 15 3/4". Seat:
H: 6 3/4" - D: 9 1/2".
54 184

W: 17 3/4" - H: 14 3/4" -
D: 15 3/4". Seat:
H: 6 3/4" - D: 9 1/2".
54 187

W: 23 1/2" - H: 14 3/4" -
D: 15 3/4". Seat:
H: 6 3/4" - D: 9 1/2".
54 190

Seat height 9 3/4":
user height 31 1/2" to 45 3/4".

W: 13 3/4" - H: 9 3/4" -
D: 13 1/2".
54 179

W: 17 3/4" -
H: 9 3/4".
54 182

W: 13 3/4" - H: 19 1/4" -
D: 21 3/4". Seat:
H: 9 3/4" - D: 11 3/4".
54 185

W: 19 3/4" - H: 19 1/4" -
D: 17 3/4". Seat:
H: 9 3/4" - D: 11 3/4".
54 188

W: 27 1/2" - H: 19 1/4" -
D: 17 3/4". Seat:
H: 9 3/4" - D: 11 3/4".
54 191

Seat height 12 1/2":
user height 42 1/2" to 56".

W: 19 3/4" - H: 12 1/2" -
D: 16".
54 180

W: 21 3/4" -
H: 12 1/2".
54 183

W: 19 3/4" - H: 23 1/2" -
D: 21 3/4". Seat:
H: 12 1/2" - D: 13 3/4".
54 186

W: 23 3/4" - H: 23 1/2" -
D: 21 3/4". Seat:
H: 12 1/2" - D: 13 3/4".
54 189

W: 39 1/4" - H: 23 1/2" -
D: 21 3/4". Seat:
H: 12 1/2" - D: 13 3/4".
54 192



Wesco innovation



Fabric made with more than 70% natural cotton, resulting in bio-sourced and Oeko-tex labels



Aqueous coated finish (solvent free), woven appearance and textured feel to prevent the material from becoming distorted



Yes
to bio-sourced
vinyl fabric!

100% made in France
in short supply chains.



BIO-BASED Basic range *Natural Colours* Respecting Nature

Because today's children are the adults of tomorrow, put at their disposal products consistent with respecting the environment by offering our seats with bio-based vinyl fabric.



Hygienic: simply wipe with a cloth or soft sponge
Resistant: high-density 1,5 lbs/ft3 foam interior: does not sag over time
No risk of injury: foam covered with vinyl fabric
Ecological: in bio-sourced vinyl fabric



 Natural colour with no added dyes. Green colour with no azo dyes.



Choice of colours:
 GREEN (008) -
 NATURAL (016)
SMALL SQUARE CUSHION



Choice of colours:
 GREEN (008) -
 NATURAL (016)
QUADRANT POUFFE



Choice of colours:
 GREEN (008) -
 NATURAL (016)
ROUND POUFFE



STRAIGHT CHAIR



COMFORT LOW CHAIR



ISLAND KIT

Seat height 6 3/4":
 user size –
 from 31 1/2".

W: 11 3/4" -
 H: 6 3/4" -
 D: 10 3/4".
60 132

L: 15 3/4" -
 H: 6 3/4".
60 135

Ø 15 3/4" -
 H: 6 3/4".
60 173

W: 11 3/4" - H: 14 3/4" -
 D: 15 3/4". Seat:
 H: 6 3/4" - D: 9 1/2".
60 128

Low chair: L: 11 3/4" -
 H: 14 3/4" - D: 15 3/4".
 Seat: H: 6 3/4" - D: 9 1/2".
 Cushion: L: 11 3/4" -
 H: 6 3/4" - D: 10 3/4".
60 138

Pouffe: W: 15 3/4" - H: 6 3/4".
 Low chair: L: 11 3/4" -
 H: 14 3/4" - D: 15 3/4".
 Seat: H: 6 3/4" - D: 9 1/2".
60 142

Seat height 9 3/4":
 size:
 31 1/2" to 45 3/4".

W: 13 3/4" -
 H: 9 3/4" -
 D: 13 1/2".
60 133

W: 17 3/4" -
 H: 9 3/4".
60 136

Ø 15" -
 H: 9 3/4".
60 174

W: 13 3/4" - H: 19 1/4" -
 D: 17 3/4". Seat:
 H: 9 3/4" - D: 11 3/4".
60 129

Low chair: L: 13 3/4" -
 H: 19 1/4" - D: 17 3/4".
 Seat: H: 9 3/4" - D: 11 3/4".
 Cushion: L: 13 3/4" -
 H: 9 3/4" - D: 13 1/2".
60 139

Pouffe: W: 17 3/4" - H: 9 3/4".
 Low chair: L: 13 3/4" -
 H: 19 1/4" - D: 17 3/4".
 Seat: H: 9 3/4" - D: 11 3/4".
60 143

Seat height 12 1/2":
 size:
 42 1/2" to 56".

W: 19 3/4" -
 H: 12 1/2" -
 D: 16".
60 134

W: 21 3/4" -
 H: 12 1/2".
60 137

Ø 23 1/2" -
 H: 12 1/2".
60 175

W: 19 3/4" - H: 23 1/2" -
 D: 21 3/4". Seat:
 H: 12 1/2" - D: 13 3/4".
60 131

Low chair: L: 13 3/4" -
 H: 23 1/2" - D: 17 3/4".
 Seat: H: 12 1/2" - D: 11 3/4".
 Cushion: L: 13 3/4" -
 H: 12 1/2" - D: 13 1/2".
60 141

Pouffe: W: 21 3/4" - H: 12 1/2".
 Low chair: L: 19 3/4" -
 H: 23 1/2" - D: 21 3/4".
 Seat: H: 12 1/2" - D: 13 3/4".
60 144



CLUB Range

Armrests: superb comfort!



Comfort and strength: 1,5 lbs/ft³ high-density foam interior (does not sag over time).

Easy clean: the vinyl fabric can be cleaned with a cloth or soft sponge, and cold soapy water.



2 YEAR GUARANTEE

MADE IN CANADA

Complies with standard EN 1021-1 and 2: flammability of filled furnishings

Phthalate-free.

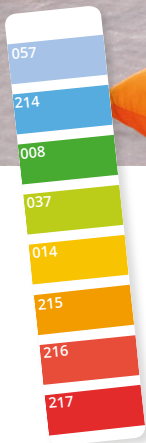

Choice of colours:
 YELLOW (014) – LIGHT ORANGE (215) – ORANGE (216) – RED (217) – LIGHT BLUE (057) – BLUE (214) – LIGHT GREEN (037) – GREEN (008)



Choice of colours:
 LIGHT BLUE / IVORY (186) – LIGHT GREEN / IVORY (187) – LIGHT ORANGE/IVORY (222)



ROUND POUFFE



SQUARE POUFFE



POUFFE



LOW CHAIR



ARMCHAIR



ARMCHAIR
Right armrest

Seat height 6 3/4":
 user size – from 31 1/2".

Ø 15 3/4" - H: 6 3/4"
01 794

L: 15 3/4" - W: 15 3/4" - H: 6 3/4".
01 793

L: 15 3/4" - W: 15 3/4" - H: 6 3/4".
65 083

L: 11 3/4" - W: 15 3/4" - H: 14 3/4".
65 086

L: 17" - W: 15 3/4" - H: 14 3/4".
65 089

L: 20 3/4" - W: 15 3/4" - H: 14 3/4".
65 092

Seat height 9 3/4":
 user height 31 1/2" to 45 3/4".

Ø 15" - H: 9 3/4".
00 860

L: 19" - W: 19" - H: 9 3/4".
00 861

L: 17 3/4" - W: 17 3/4" - H: 9 3/4".
65 084

L: 17 1/2" - W: 17 3/4" - H: 21 3/4".
65 087

L: 22 3/4" - W: 17 3/4" - H: 21 3/4".
65 090

L: 27 1/2" - W: 17 3/4" - H: 21 3/4".
65 093

Seat height 12 1/2":
 user height 42 1/2" to 56".

Ø 23 1/2" - H: 12 1/2".
00 645

L: 23 1/2" - W: 23 1/2" - H: 12 1/2".
00 644

L: 17 3/4" - W: 17 3/4" - H: 12 1/2".
65 085

L: 19" - W: 18" - H: 23 1/2".
65 088

L: 24 1/2" - W: 18" - H: 23 1/2".
65 091

L: 31 1/2" - W: 18" - H: 23 1/2".
65 094



Choice of colours:
 LIGHT BLUE / IVORY (186) -
 LIGHT GREEN / IVORY (187) -
 LIGHT ORANGE/IVORY (222)



Club Sofa corner KIT
 1 sofa, 1 armchair, 1 pouffe.

Height 6 3/4" Ground space: 42 1/2" x 40 1/4".	Height 9 3/4" Ground space: 53 1/4" x 50 1/4".	Height 12 1/2" Ground space: 56" x 52 1/4".
65 105 set	65 109 set	65 111 set



Choice of colours:
 LIGHT BLUE / IVORY (186) -
 LIGHT GREEN / IVORY (187) -
 LIGHT ORANGE/IVORY (222)



Club Large sofa KIT
 1 armchair with right armrest, 1 armchair
 with left armrest, 2 pouffes.

Height 6 3/4" Ground space: 41 3/4" x 41 1/4".	Height 9 3/4" Ground space: 55" x 45 1/4".	Height 12 1/2" Ground space: 63" x 45 3/4".
65 112 set	65 113 set	65 116 set



Choice of colours:
 LIGHT BLUE / IVORY (186) -
 LIGHT GREEN / IVORY (187) -
 LIGHT ORANGE/IVORY (222)



Club Corner sofa KIT
 1 armchair with right armrest, 1 armchair with left armrest,
 1 corner armchair, 1 pouffe.

Height 6 3/4" Ground space: 37 3/4" x 37 3/4".	Height 9 3/4" Ground space: 50 1/4" x 50 1/4".	Height 12 1/2" Ground space: 56" x 56".
65 118 set	65 120 set	65 121 set



ARMCHAIR
Left armrest **CORNER ARMCHAIR** **SOFA**

L: 20 3/4" - W: 15 3/4" L: 17" - W: 17" L: 24 1/2" - W: 15 3/4"
 - H: 14 3/4". - H: 14 3/4". - H: 14 3/4".
65 095 **65 098** **65 102**

L: 27 1/2" - W: 17 3/4" L: 22 3/4" - W: 22 3/4" L: 35 1/2" - W: 17 3/4"
 - H: 21 3/4". - H: 21 3/4". - H: 21 3/4".
65 096 **65 099** **65 103**

L: 31 1/2" - W: 18" L: 24 1/2" - W: 24 1/2" L: 24 1/2" - W: 18"
 - H: 23 1/2". - H: 23 1/2". - H: 23 1/2".
65 097 **65 101** **65 104**



Choice of colours:
 LIGHT BLUE / IVORY (186) -
 LIGHT GREEN / IVORY (187) -
 LIGHT ORANGE/IVORY (222)



Club Large corner sofa KIT
 1 armchair with left armrest, 2 low chairs, 1 corner armchair,
 1 pouffe.

Height 6 3/4" Ground space: 44 1/2" x 49 1/2".	Height 9 3/4" Ground space: 67 3/4" x 57 3/4".	Height 12 1/2" Ground space: 82 3/4" x 69".
65 122 set	65 129 set	65 132 set



DELTA Range

Friendliness and flexibility!

Available in 3 shapes and with 2 different bases, our Delta seats can be combined together to create large reading and group spaces. Want to create a space for relaxation? Quickly rearrange your set and invite children to feel "at home".



Comfort and strength: 1,5 lbs/ft³ high-density foam interior (does not sag over time).
Easy clean: the vinyl fabric can be cleaned with a cloth or soft sponge, and cold soapy water.



Choice of colours:
 LIGHT BLUE (057) - LIGHT GREEN (037) - YELLOW (014)
 BLUE (214) - GREEN (008) - LIGHT ORANGE (215)
 GREEN/LIGHT GREEN (169) - BLUE/LIGHT BLUE (218) -
 YELLOW/LIGHT ORANGE (219)

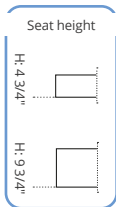
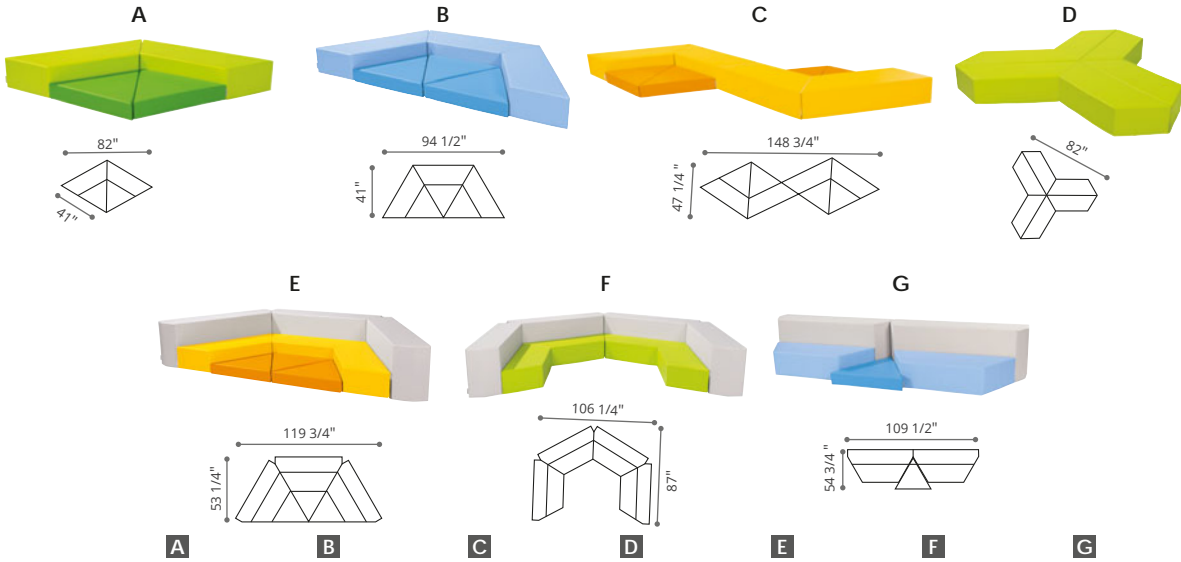

+ 18 months
To be placed on the ground

Delta SMALL CORNER KIT

60 774 set

Delta SMALL AGORA KIT

60 768 set

Delta LOVE SEAT KIT

60 772 set

Delta TRIPOD KIT

60 766 set

Delta LARGE AGORA KIT

60 776 set

Delta LARGE MEETING KIT

60 793 set

Delta TWIN BENCH KIT

60 778 set



wesco
design

2 YEAR GUARANTEE

MADE IN CANADA

Phthalate-free.

new

KIDY S'COOL foam island

Friendliness and flexibility!

Available in different heights, these seats can be used on their own, combined in an island to create a large meeting area or combined with our range of Kidy S'cool furniture to create a classroom where everything can be easily moved based on the activities.



Choice of colours: WHITE (001) - LIGHT BLUE (057) - BLUE (214) - TEAL (223) - LICHEN (122) - FABRIC EFFECT GREEN (191) - GREEN (008) - LIGHT GREEN (037) - YELLOW (014) - LIGHT ORANGE (215) - ORANGE (216) - RED (217) - SAND (135) - IVORY (138) - LIGHT GREY (180) - FABRIC EFFECT GREY (193)

Made from High-density VINYL-COVERED FOAM.

LAYOUT AND FURNITURE

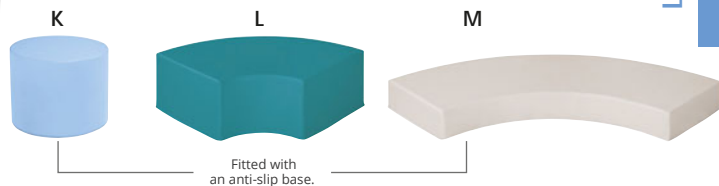

Fitted with an anti-slip base.

K Basic ROUND POUFFE **L** QUARTER CIRCLE **M** LARGE QUARTER CIRCLE

Ø 19 3/4" - H: 15 3/4".
56 462
each

L: 27 1/2" - H: 11" -
Seat D: 17 3/4".
68 214
each

L: 45 1/4" - H: 5 1/2" -
Seat D: 17 3/4".
68 216
each

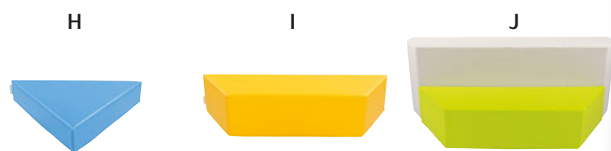

H
Delta TRIANGLE POUFFE

60 717
each



I
Delta TRAPEZIUM POUFFE

60 716
each



J
Delta BENCH

60 749
each

THE ISLAND

Ø 90 1/2". Made from VINYL COVERS.
washable using a soft cloth in cold soapy water.
Fitted with an anti-slip base. Choice of colours:
LIGHT BLUE / IVORY (186) -
TEAL/IVORY (226) - LICHEN/IVORY (227) -
LIGHT GREEN / IVORY (187)
68 288 set

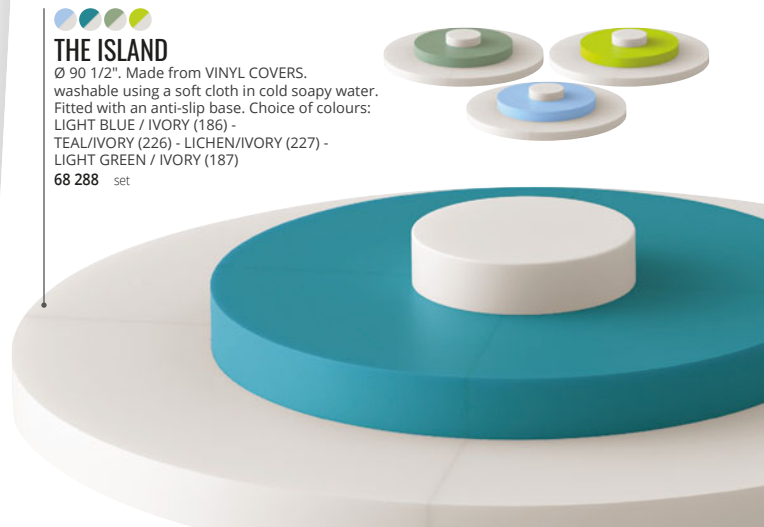



wesco
design

2 YEAR GUARANTEE

MADE IN CANADA

Complies with standard
EN 1021-1 and 2:
flammability
of filled furnishings

Phthalate-free.

TIC TAC range

*Firm rounded
support.*

+ **Comfort and strength:** 1,5 lbs/ft³ high density foam interior (does not sag over time)

Hygienic: the vinyl fabric is easy to clean with a cloth or soft sponge in cold soapy water.

No risk of injury: foam entirely covered with vinyl fabric.

Seat height: 7 3/4".

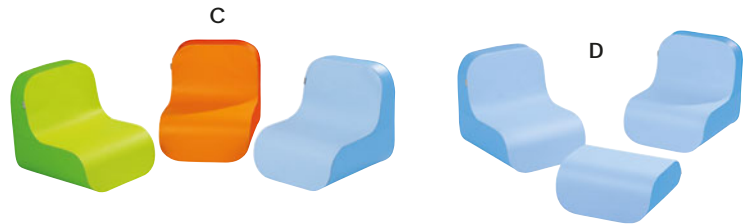
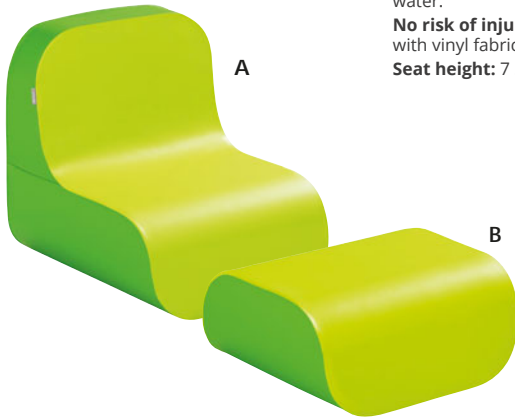

Tic Tac range Washable using a soft cloth in cold soapy water. Choice of colours: GREEN/LIGHT GREEN (169) - BLUE/LIGHT BLUE (218) - ORANGE/LIGHT ORANGE (220)

A Tic Tac LOW CHAIR	L: 19 1/4" - W: 17" - H: 18 1/2".	49 673	each
B Tic Tac POUFFE / TABLE / FOOTREST	L: 17" - W: 15 3/4" - H: 7 3/4".	49 674	each

Choice of colours: MULTICOLOURED (020) - GREEN/LIGHT GREEN (169) - BLUE/LIGHT BLUE (218) - ORANGE/LIGHT ORANGE (220)



C KIT of 3 Tic Tac LOW CHAIRS	L: 19 1/4" - W: 17" - H: 18 1/2".	66 729	set
D Tic Tac LOUNGE KIT	Low chair: L: 19 1/4" - W: 17" - H: 18 1/2".	66 730	set



KIA Rocking chair

*A completely
safe rocking
chair!*

Children 35 1/2" to 45 3/4" tall.



Kia SEAT Made from High-density FOAM covered with VINYL FABRIC (seat) and EPOXY finished METAL (frame). Choice of colours: WHITE (001) - BLUE/IVORY (224) - LIGHT GREEN / IVORY (187) - LIGHT ORANGE/IVORY (222)

Child	L: 18" - W: 14 1/2" - H: 18 1/2".	54 872	each
--------------	-----------------------------------	--------	------

Fabric and foam,
safe for hands.

LILOO Range

for children
35 1/2" to 41 1/4" tall.

A very sturdy plastic body and a comfortable foam seat for an original range designed with children in mind.



Liloo ARMCHAIR L: 19" - W: 19" - H: 19 3/4" - Seat D: 11 3/4" - Seat H: 10 1/4". Made from PLASTIC and VINYL COVERS. Choice of colours: DARK GREEN/LIGHT GREEN (025) - BLUE/LIGHT BLUE (218) - ORANGE/LIGHT ORANGE (220)

20 043 each



Liloo SOFA L: 37 3/4" - W: 19" - H: 19 3/4" - Seat D: 11 3/4" - Seat H: 10 1/4". Made from PLASTIC and VINYL COVERS. Choice of colours: DARK GREEN/LIGHT GREEN (025) - BLUE/LIGHT BLUE (218) - ORANGE/LIGHT ORANGE (220)

20 042 each

Little comfort Liloo kit

Consists of: 1 Liloo armchair, 1 Liloo sofa

56 863 set

Big comfort Liloo kit

Consists of: 2 Liloo armchairs, 1 Liloo sofa

56 864 set



Liloo container on castors Consists of: 1 Liloo container, 4 castors and 1 lid. Capacity: 8,45 gal. L: 19" - W: 19" - H: 14 1/4". Made from thick POLYETHYLENE. For indoor and outdoor use. Choice of colours: DARK GREEN/LIGHT GREEN (025) - LIGHT BLUE/BLUE (114) - LIGHT ORANGE / ORANGE (195)

56 862 each

E LID FOR Liloo CONTAINER L: 19" - W: 19" - th: 3 1/4". Made from thick POLYETHYLENE. Choice of colours: BLUE (002) - GREEN (008) - ORANGE (007)

20 045 each

F Liloo CONTAINER Capacity: 8,45 gal. L: 19" - W: 19" - H: 14 1/4". Made from thick POLYETHYLENE. Choice of colours: LIGHT BLUE (057) - LIGHT GREEN (037) - LIGHT ORANGE (164)

20 044 each

G CASTORS for storage container

20 046 pack of 4

LUNA range

for height from
42 1/2" to 56"

In a line, a circle or the shape of a star, these pouffes have endless layout possibilities.

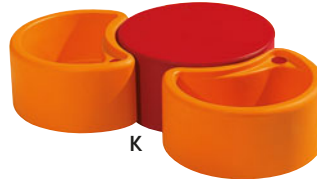
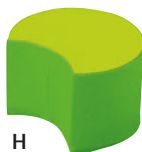

H Luna POUFFE Small size Ø 15" - H: 9 3/4". Made from VINYL COVERS. washable with water. For indoor and outdoor use. Choice of colours: GREEN/LIGHT GREEN (169) - BLUE/LIGHT BLUE (059) - ORANGE/LIGHT ORANGE (168)

01 992 each

I Luna POUFFE Large size Ø 23 1/2" - H: 12 1/2". Made from VINYL COVERS. Indoor use. Choice of colours: GREEN/LIGHT GREEN (169) - BLUE/LIGHT BLUE (218) - ORANGE/LIGHT ORANGE (220)

01 989 each

J LUNA CONTAINER Capacity: 7,66 gal. Ø 23 1/2" - H: 11 3/4". Made from thick POLYETHYLENE. For indoor and outdoor use. Choice of colours: BLUE (002) - GREEN (008) - ORANGE (007)

20 047 each

K Luna "Triangle" KIT Consists of: 2 Luna containers and 1 large round pouffe. Made from COATED and PLASTIC FABRIC. Colours RED/ORANGE (221)

20 167 set

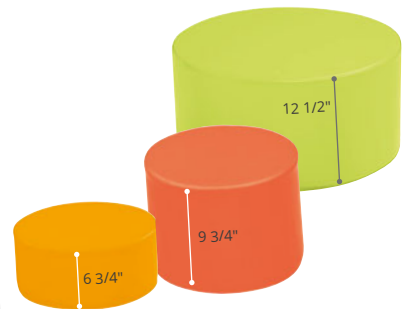

ROUND POUFFE

Choice of colours: WHITE (001) - LIGHT BLUE (057) - BLUE (214) - TEAL (223) - LICHEN (122) - GREEN (008) - SPRING GREEN (104) - LIGHT GREEN (037) - YELLOW (014) - LIGHT ORANGE (215) - ORANGE (216) - RED (217) - SAND (135) - IVORY (138) - LIGHT GREY (180)

Basic - H: 6 3/4"
Ø 15 3/4" - H: 6 3/4".

01 794 each

Basic - H: 9 3/4"
Ø 15" - H: 9 3/4".

00 860 each

Basic - H: 12 1/2"
Ø 23 1/2" - H: 12 1/2".

00 645 each



MOSAIC activity areas

A colourful, safe *patchwork* play mat suitable for very young children!

From birth
for use under adult supervision



Safe: made from 1,5 lbs/ft³ density foam covered with jersey-lined vinyl fabric.
Hygienic: the vinyl fabric is easy to clean with either a soft cloth or sponge and cold soapy water.
Clever: connect together securely using the velcro strips provided.



2 YEAR GUARANTEE

MADE IN CANADA

Complies with standard EN 1021-1 and 2: flammability of filled furnishings
Phthalate-free.

MOSAIC MAT KIT First steps

Consists of: 5 components: 2 Mosaic containers, and 3 x 19x37 3/4" mats. Ground space: 75 1/2 x 37 3/4". Made from 1,5 lbs/ft3 density POLYETHER FOAM covered in a jersey-based VINYL FABRIC. washable with a sponge.

66 711 set

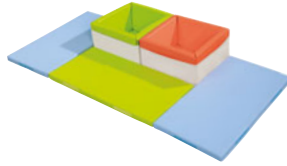

MOSAIC MAT KIT Oasis

Consists of: 8 components: 2 Mosaic containers, 4 x 19x37 3/4" mats, 2 x 19x19" mats. Ground space: 75 1/2 x 56 3/4". Made from 1,5 lbs/ft3 density POLYETHER FOAM covered in a jersey-based VINYL FABRIC. washable with a sponge.

66 712 set



Large capacity
Anti-slip base.



MOSAIC MAT KIT Reading space

Consists of: 7 components: 4 Mosaic containers, 2 x 19x37 3/4" mats, 1 x 37 3/4x37 3/4" mat. Ground space: 75 1/2 x 56 3/4". Made from 1,5 lbs/ft3 density POLYETHER FOAM covered in a jersey-based VINYL FABRIC. washable with a sponge.

66 713 set

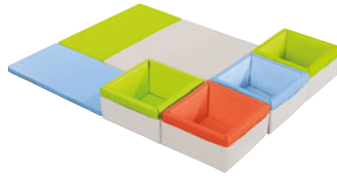

Mosaic CONTAINER The removable sides mean that these containers can be stored easily in small spaces. L: 19" - W: 19" - H: 9 1/2". Made from FOAM and VINYL COVERS washable with a sponge. Fitted with an anti-slip base. Choice of colours: WHITE (001) - LIGHT BLUE / IVORY (186) - LIGHT GREEN / IVORY (187) - ORANGE/IVORY (225)

39 567 each

MOSAIC MAT KIT Island

Consists of: 10 components: 2 Mosaic containers, 4 x 19x37 3/4" mats, 2 x 19x19" mats, 2 x 37 3/4x37 3/4" mats. Ground space: 94 1/2" x 75 1/2". Made from 1,5 lbs/ft3 density POLYETHER FOAM covered in a jersey-based VINYL FABRIC. washable with a sponge.

66 714 set



MOSAIC MAT KIT Storage

Consists of: 9 components: 4 Mosaic containers, 4 x 19x37 3/4" mats, 1 x 37 3/4x37 3/4" mat. Ground space: 75 1/2" x 75 1/2". Made from 1,5 lbs/ft3 density POLYETHER FOAM covered in a jersey-based VINYL FABRIC. washable with a sponge.

66 715 set



BACKREST Designed to fit the dimensions of our barriers, these backrests allow you to create areas inside your playpens which are even more comfortable and safe. H: 21 1/4" - th: 7 3/4". Made from Polyether FOAM 1,3 lbs/ft3 density, covered with a VINYL cover. Fitted with an anti-slip base. Choice of colours: LIGHT BLUE (057) - LIGHT ORANGE (215)

each

W: 19".	26 784
W: 37 3/4".	26 785
CORNER	26 786

MOSAIC MAT KIT Corner wall space

Consists of: 2 Mosaic containers, 3 x 37 3/4 x 19" mats, 1 x 37 3/4 x 37 3/4" mat, 3/4 x 37 3/4" mat, 1/2 x 19" backrests, 1/2 x 19" backrest and 1 corner backrest. Ground space: 75 1/2 x 56 3/4". Made from 1,5 lbs/ft3 density POLYETHER FOAM covered in a jersey-based VINYL FABRIC. washable with a sponge.

66 716 set





Hygienic: can be cleaned with a sponge and disinfected
Easy to install
Heavy duty: made of thick plastic
Modular: can be used alone or assembled with 2 or 3



100% recyclable.

 **wesco**
design

3 YEAR GUARANTEE

MADE IN FRANCE

Complies with standard EN 71-8 Complies with toy standards: EN 71 1, 2 and 3

Supplied with a wall fixing plate



TIO'LA cabin

+ 12 months
for use under adult supervision

Reassuring areas for children

Children love hiding away in a cabin and creating a cosy cocoon. The Tio'la cabin can be set up in a flash for playing or resting.



A



A
Tio'la cabin L: 19 3/4" - W: 48 1/2" (39 1/4" interior) - H: 50". Made from thick POLYETHYLENE, washable with a sponge. For indoor and outdoor use. Supplied with a wall fixing plate. Choice of colours: WHITE (001) - BLUE (002) - LIGHT GREEN (037) - LIGHT ORANGE (164)

50 353 each



B



C



D



E

Choice of colours: LIGHT GREEN/BLUE (009) - BLUE/ORANGE (097) - ORANGE/GREEN (098)

B	Tio'la cabin	L: 39 1/4" - W: 48 1/2" (39 1/4" interior) - H: 50".	49 996
C	Tio'la cabin	L: 59" - W: 48 1/2" (39 1/4" inside) - H: 50".	49 997
D	Tio'la cabin	L: 59" - W: 48 1/2" (39 1/4" interior) - H: 50".	49 998
E	Tio'la cabin	L: 59" - W: 48 1/2" (39 1/4" interior) - H: 50".	49 999



set

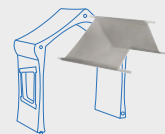

Tio'la Roof Canvas Made from PLASTIC and SYNTHETIC FABRIC. Indoor use. Colours GREY (006)

49 995 each

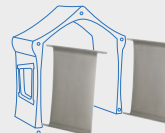

Tio'la Wall Canvas Made from PLASTIC and SYNTHETIC FABRIC. Indoor use. Colours GREY (006)

49 994 each



Tio'la cabin For joining two Tio'la cabins together. Made from EPOXY finished METAL. For indoor and outdoor use.

61 665 each



wesco
design

3 YEAR GUARANTEE

Complies with toy standards: EN 71 1, 2 and 3

Phthalate-free.

Delivered flat-packed, do-it-yourself installation.

- +** Safe: openings for easier supervision
- Sturdy:** in varnished plywood
Easy to assemble
Optimised space
- Multi-function:** suitable for our role-play and reading furniture
- From eco-managed forests**



Scan the QR Code to view this product in 360° and augmented reality in your room!

BABI UP cabin

+ 12 months
for use under adult supervision

A space inviting relaxation and adventure!

Ideal for getting together, resting, playing and sharing secrets, the Babi Up wood cabin is a separate space where children will love to meet up.

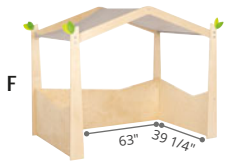

F + 12 months
Babi Up cabin Floor space: L: 63" - W: 39 1/4" - H: 51 1/4". Made from WOOD (structure) and ventilated VINYL FABRIC (roof), washable with water. Delivered flat-packed, do-it-yourself installation.
58 476 each



Babi Up cabin Made from WOOD (structure) and ventilated VINYL FABRIC (roof). Washable with water. Indoor use. Delivered flat-packed, do-it-yourself installation. Choice of colours: WHITE (001) - LIGHT BLUE (057) - LIGHT GREEN (037) - LIGHT ORANGE (215)

Model	Age	Description	Price
G Comfort	+ 12 months	1 cabin and 1 Mosaic comfort mat.	58 475
H The Nest	+ 12 months	1 cabin, 1 Mosaic comfort mat and 5 backrests.	58 474
I The living room	+ 18 months	1 cabin, 2 x 3-seater benches and 2 Basic small square cushions.	58 494
J Reading	+ 18 months	1 cabin, 5 square cushions and 1 vinyl fabric container.	61 819
K Kitchen	+ 2 years	1 cabin, 1 "Chef's Assistant" cooker, 1 sink and 1 washing machine.	58 493



3 YEAR GUARANTEE

Delivered flat-packed, do-it-yourself installation.

+ 9 months for use under adult supervision

UBLO BARRIER

The "featherweight" barrier!

Our decorative and cleverly designed Ublo barriers reinvent partitioning for spaces and playpens. Suitable for both indoor and outdoor use, they're the perfect combination of attractive functionality with their lightweight design, rounded lines and soft colours. Designed to make life easier for supervisors, they fold away easily accordion-style, for optimal space saving thanks to the compact dimensions.



Lightweight: (fewer than 8,8lbs) and compact (L: 37 3/4" - H: 27 1/4")

Easy to move

Fully washable

Maximum safety

Anti-pinch system for finger protection

No sharp components likely to injure a child

Slatted openings ensure constant visual contact

between children and supervisors

Can be attached to the floor

(fixings not supplied, dependent on floor type)



100% recyclable.



Activities on both sides!

folds like a concertina along a wall



Transparent : to say hello from the window!

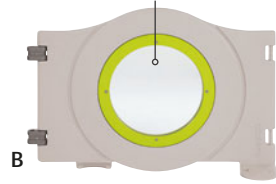
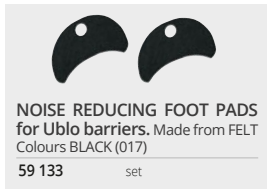
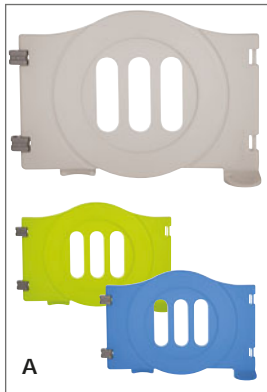

Mirror : to play with its reflections!

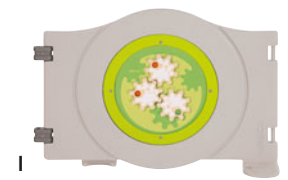
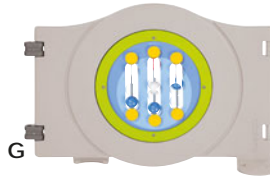
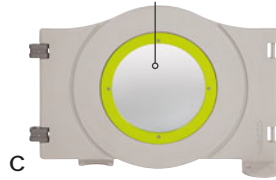

Ublo BARRIER L: 37 3/4" - H: 27 1/4" - th: 1 1/2" - width of foot: 21 1/2". Weight of barrier: 8,8lbs. Made from thick POLYETHYLENE (frame) and WOOD (activities). Washable with water. Delivered flat-packed, do-it-yourself installation.

For indoor and outdoor use. each

	Choice of colours: BLUE (N02) - LIGHT GREEN (N37) - GREY (006)	
A With bars		51 805
Indoor use. each		
B Window		51 809
C MIRROR		51 812
D Steering wheel		51 813
E Car		51 814
F The fish		51 815
G Abacus		51 816
H Decorative		51 817
I Gears		51 818
J Water		51 819

K UBLO GATE KIT Made from thick POLYETHYLENE. washable with water. For indoor and outdoor use. Delivered flat-packed, do-it-yourself installation. Foot pads included. Colours GREY (006)
58 603 set

L UBLO WALL ATTACHMENT
With this wall attachment you can make your arrangement of barriers into a permanent, sturdy space divider. Accordion folded along this attachment, the barriers will not take up much space. L: 3" - W: 1 1/2" - H: 16 1/2". Made from thick POLYETHYLENE. For indoor and outdoor use. Delivered flat-packed, do-it-yourself installation. Screws and bolts are not supplied, these will depend on your wall type. Colours GREY (006)
51 823 set

Complete closure for added safety.



Ready to use kits

For indoor and outdoor use.



Scan the QR Code to view this product in 360° and augmented reality in your room!



Ublo The Basics KIT Consists of: 6 slatted barriers, 1 gate kit and 2 wall mounts. 1 barrier: L: 37 3/4" - H: 27 1/4" - th: 1 1/2" - width of foot: 21 1/2". Weight: 8,8 lbs. Made from thick POLYETHYLENE, washable with water. Delivered flat-packed, do-it-yourself installation. Fixing screws are not supplied (they depend on your floor type). Choice of colours: BLUE (002) - LIGHT GREEN (037) - GREY (006) - GREY/GREEN (176) - GREY/BLUE (152)

59 226 set

Ublo KIT Made from thick POLYETHYLENE. Washable with water. For indoor and outdoor use. Fixing screws are not supplied (they depend on your floor type). Delivered flat-packed, do-it-yourself installation. Choice of colours: GREY/GREEN (176) - GREY/BLUE (152)

A	Ublo KIT	4 Ublo slatted barriers.	51 827	set
B	Ublo LARGE KIT	8 Ublo slatted barriers.	51 828	set

The smallest children are easily visible!



Ublo Transparent KIT Consists of: 1 Mirror barrier, 1 Barred barrier, 1 Decorative barrier, 1 Window barrier. Indoor use. Delivered flat-packed, do-it-yourself installation. Fixing screws are not supplied (they depend on your floor type).

51 830 set

With activities that promote fine motor skills!



Ublo activity KIT Consists of: 1 Steering wheel barrier, 1 Car barrier, 1 Fish barrier, 1 Abacus barrier, 1 Water barrier, 1 Gears barrier. Made from thick POLYETHYLENE, washable with water. Indoor use. Delivered flat-packed, do-it-yourself installation. Fixing screws are not supplied (they depend on your floor type).

51 831 set



Ublo square KIT Consists of: 4 slatted barriers, 1 Mirror barrier, 1 Abacus barrier, 1 water barrier, 1 Gears barrier, 1 gate kit. Indoor use. Delivered flat-packed, do-it-yourself installation. Fixing screws are not supplied (they depend on your floor type). Choice of colours: GREY/GREEN (176) - GREY/BLUE (152)

59 227 set





wesco
design
2 YEAR GUARANTEE
MADE IN CANADA

Can be wrapped around poles Ø 11 3/4" maximum.

From birth



+ 9 months
Pencil CORNER PROTECTOR Fixed with flame retardant silicone glue. L: 39 1/4" - W: 2 3/4" - D: 2 3/4". Made from POLYURETHANE foam. For indoor and outdoor use. Choice of colours: BLUE (002) - YELLOW (014) - RED (011)
44 334 each

ANTI-SHOCK MOBILE partitions

Separates spaces and protects children

- +** **Hygienic:** the vinyl fabric is easy to clean with a soft cloth or sponge in cold soapy water
- Safe:** foam interior
- Long-lasting:** high-density 1,5 lbs/ft3 foam
- Mobile solution:** perfect for all spaces
- Modular:** combine partitions with their self-adhering bands

Very lightweight, our mobile partitions can be quickly installed to create spaces and privacy. They are flexible and can be wrapped around poles to provide protection for children.

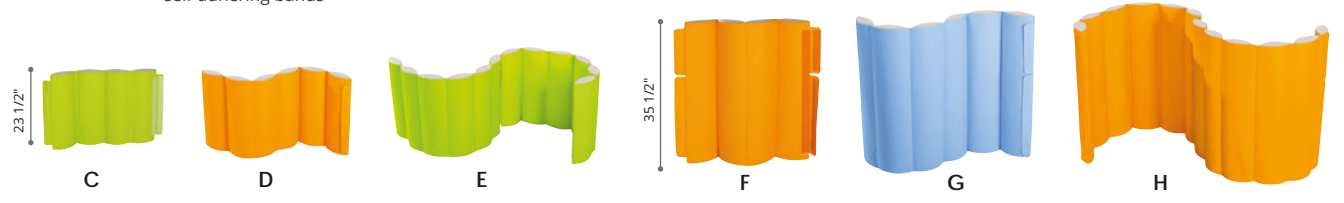

ANTI-SHOCK MOBILE PARTITION Very lightweight, our mobile partitions can be quickly installed to create spaces and privacy. They are flexible and can be wrapped around poles to provide protection for children. Made from FOAM and VINYL COVERS. Indoor use. Choice of colours: LIGHT BLUE / IVORY (186) - LIGHT GREEN / IVORY (187) - LIGHT ORANGE/IVORY (222)

Can be wrapped around poles Ø 4 3/4" maximum.		each
E	L: 31 1/2" - H: 23 1/2"	58 503
Can be wrapped around poles Ø 11 3/4" maximum.		each
F	L: 49 1/4" - H: 23 1/2"	45 478
G	2 SMALL ANTI-SHOCK MOBILE PARTITIONS KIT	45 482 pack of 2
		each
H	L: 31 1/2" - H: 35 1/2"	58 505
		each
I	L: 49 1/4" - H: 35 1/2"	45 479
J	2 LARGE ANTI-SHOCK MOBILE PARTITIONS KIT	45 483 pack of 2



COCOON range

Ideal for transitioning between a cot and a stackable bed, the contour Cocoon mattress encourages freedom of movement in children: it's easily accessed by very young children who will be able to go to bed and get up independently. Its position at floor level also minimises the risk of falling and so, reassures children.

Specially designed for the very young!
Higher edges.

A 2 to 6 months

B 6 months to 3 year

Do not fold.
Risk of deformation.

C 6 months to 3 year

2 stacked contours H: 11 3/4"
- Weight: 6,4 lbs (per unit).
D 6 months to 3 year

With environment-friendly bio-based vinyl fabric.

E 6 months to 3 year



CONTOUR COCOON MATTRESS

Made from 1,5 lbs/ft3 density POLYETHER FOAM, covered with VINYL FABRIC. Washable with water. Delivered without mattress.
Choice of colours: LIGHT BLUE (057) - TEAL (223) - LICHEN (122) - LIGHT GREEN (037) - LIGHT ORANGE (215) - IVORY (138)



A Space saving	L: 45" - W: 25 1/4" - H: 11 3/4" - th.: 2 3/4" - Weight: 8,4lbs.	Use with a mattress 39 1/4 x 19 3/4".	51 969
B Standard	L: 52 3/4" - W: 29 1/4" - H: 9 3/4" - th.: 2 3/4" - Weight: 13,9lbs.	For use with a 47 1/4 x 23 1/2" mattress.	51 966
C Demi-contour	L: 26 1/2" - W: 29 1/4" - H: 9 3/4" - th.: 2 3/4" - Weight: 5,7lbs.	For use with a 47 1/4 x 23 1/2" mattress.	51 968

pack of 2

D Slim new	L: 52 3/4" - W: 29 1/4" - head : H: 7 3/4" - foot: H: 4".	For use with a 47 1/4 x 23 1/2" mattress.	68 315
--------------------------	---	---	---------------

Choice of colours: GREEN (008) - NATURAL (016)



E Standard version in bio-based coated fabric	L: 52 3/4" - W: 29 1/4" - H: 9 3/4" - th: 2 3/4" - Weight: 13,9 lbs.	For use with a 47 1/4 x 23 1/2" mattress.	60 087
--	--	---	---------------

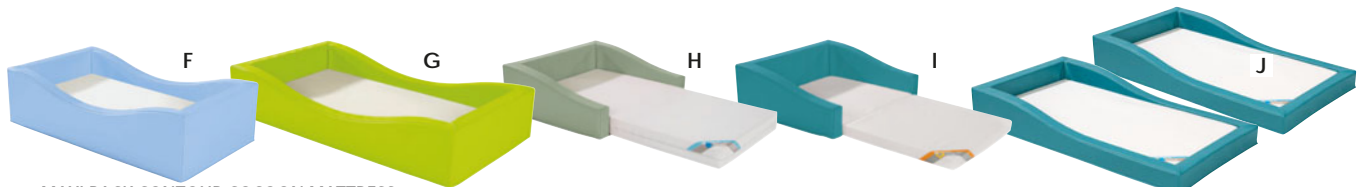

MAXI PACK CONTOUR COCOON MATTRESS

Choice of colours: LIGHT BLUE (057) - TEAL (223) - LICHEN (122) - LIGHT GREEN (037) - LIGHT ORANGE (215) - IVORY (138)



F Space saving and small waterproof mattress	51 978	set
G Standard and waterproof mattress	51 974	set
H Demi-contour and waterproof mattress	51 976	set
I Demi-contour and folding mattress	52 034	set
J Slim and 2 waterproof mattresses new	68 317	set



Pouffe, armchair or mattress.

wesco
design

2 YEAR GUARANTEE

MADE IN CANADA

Sleeping on the floor Easy to set up

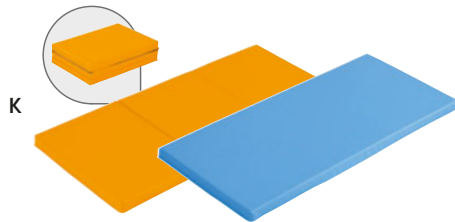

K 1 to 6 years old

NAP MATTRESS Comfortable and easy to move, children can rest and take long naps on this floor mattress. Made from VINYL COVERS. Washable with water. Choice of colours: BLUE (214) - LIGHT GREEN (037) - LIGHT ORANGE (215)

One piece L: 47 1/4" - W: 21 1/4" - th: 1 1/2". Weight: 6,3 lbs.
49 603 each

Foldable Folded: L: 15 3/4" - W: 21 1/4" - H: 4 3/4". Unfolded: L: 47 1/4" - W: 21 1/4" - th: 1 1/2". Weight: 4,2 lbs.

49 601 each

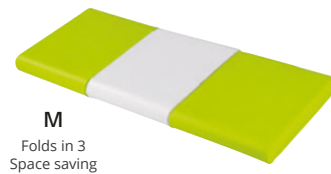

M
Folds in 3
Space saving



M 1 to 6 years old

POUFFE MATTRESS Folded: L: 19 3/4" - W: 23 1/2" - H: 11 3/4". Unfolded: L: 119 3/4" - W: 23 1/2" - th: 4". Made from VINYL COVERS. washable with water. Choice of colours: LIGHT GREEN (037) - LIGHT GREY (180)

49 525 each

L 1 to 6 years old

CONVERTIBLE LOW CHAIR For children 35 1/2" to 41 1/4" tall. Folded: L: 19" - W: 23 1/2" - H: 19 1/4". Unfolded: L: 56 3/4" - W: 23 1/2" - H: 12 1/2". Sleeping area: L: 49 1/2". Made from VINYL COVERS. washable using a soft cloth in cold soapy water. Fitted with an anti-slip base. Choice of colours: WHITE (001) - GREEN/LIGHT GREEN (169) - BLUE/LIGHT BLUE (218) - ORANGE/LIGHT ORANGE (220) - RED/ORANGE (221)

27 106 each

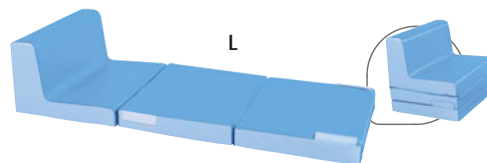



wesco
design

2 YEAR GUARANTEE

MADE IN CANADA

Phthalate-free.

From birth

A Flexible and thick FLOOR MAT Shockproof in case of falling objects, its density helps to keep a good balance. L: 78 3/4" - W: 19 3/4" - TH: 3/4". Made from AGGLOMERATED POLYURETHANE FOAM, density 9,4 lbs/ft3. washable with water. Choice of colours: BLUE (214) - ORANGE (216)

00 608 each

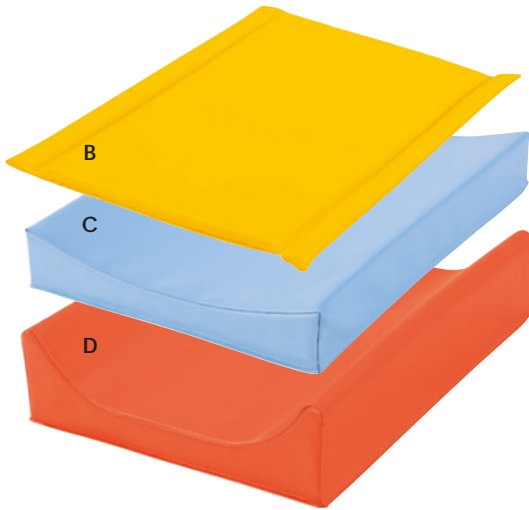

MATELAS DE CHANGE Made from POLYETHER FOAM covered with VINYL FABRIC. Washable with water. Choice of colours: LIGHT BLUE (057) - TEAL (223) - LICHEN (122) - LIGHT GREEN (037) - YELLOW (014) - LIGHT ORANGE (215) - ORANGE (216) - LIGHT GREY (180) - GREEN (008) - NATURAL (016)

each

B	Best value	L: 27 1/2" - W: 19 3/4" - th: 3/4". Density 1,2 lbs/ft3.		45 179
C	Curved	L: 27 1/2" - W: 19 3/4" - th: 5 to 4". Density 1,2 lbs/ft3.		00 114
D	Maximum Safety	L: 27 1/2" - W: 19 3/4" - Th: 5 to 6". Density 1,5 lbs/ft3.		42 794
E	High sides in bio-sourced fabric.	L: 27 1/2" - W: 19 3/4" - th: 5 to 6". Density 1,5 lbs/ft3.		60 083
F	L: 100 x W: 27 1/2"	L: 39 1/4" - W: 27 1/2" - th: 1 1/2". Density 1,2 lbs/ft3.		54 278

Finished with towels that glide!

Absorbent and soft.
Dries gently.



TOWELLING CHANGING MAT PROTECTOR

Choice of colours: LIGHT BLUE (057) - LIGHT GREEN (037)

45 233 each



Seeking a customised layout?

Contact your regional sales advisor (see the service guide at the start of this catalogue).

MADE-TO-MEASURE FLEXIBLE, THICK FOAM MATS th: 3/4" Max Size: 2 m x 1.6 m. Min Size: 19 3/4" x 27 1/2". Made from AGGLOMERATED POLYURETHANE FOAM, density 9,4 lbs/ft3. washable with water. Delivered in under 6 weeks.

59 312 per sq. m

CUSTOMISED CHANGING MAT th: 1 1/2". Size. maxi: 2 m x 1.6 m. Size. mini: 19 3/4" x 27 1/2". Made from POLYETHER FOAM covered with jersey-lined VINYL FABRIC. Delivered in under 6 weeks.

02 986 per sq. m





+ **Comfort and strength:** high-density 1,5 lbs/ft³ foam interior (does not sag over time)
Hygienic: the vinyl fabric is easy to clean with either a soft cloth or sponge and cold soapy water.
Secure: made entirely of foam covered with vinyl fabric. Non-toxic screen-printed design.

wesco
design

2 YEAR GUARANTEE

MADE IN CANADA

Complies with standard
NFS 54-300 :
motor activity safety
Phthalate-free.

1 to 4 years
for use under adult supervision

Decofoam range

As children sit, crawl and jump on these Decofoam play items, they exercise both their imagination and their motor skills.

Self-identification, body awareness and expression using language form the basis of the essential educational benefits of the Decofoam range. Children identify with the characters driving a racing car, riding animals, etc. The larger Decofoam items can be used by several children at once!

DECOFOAM ZOOZIOS. Washable using a soft cloth in cold soapy water.

		each
G Lez	L: 43 1/4" - W: 7 3/4" - H: 17 1/4" - Seat H: 7 3/4".	57 281
H Diz	L: 40 1/4" - W: 7 3/4" - H: 16 1/4" - Seat H: 7 3/4".	57 282
I Noz	L: 15 3/4" - W: 7 3/4" - H: 15 3/4" - Seat H: 7 3/4".	57 279
J Fuz	L: 26" - W: 7 3/4" - H: 11 3/4" - Seat H: 7 3/4".	57 278

G+H+I+J DECOFOAM ZOOZIOS pack of 4 57 435

DECOFOAM VEHICLES Washable using a soft cloth in cold soapy water.

		each
K Tchou	L: 45 1/4" - W: 7 3/4" - H: 7 3/4" - Seat H: 7 3/4".	57 284
L Vroom	L: 33" - W: 7 3/4" - H: 11" - Seat H: 7 3/4".	57 283

K+L DECOFOAM VEHICLES pack of 2 57 436





Giant cushions

From birth

Large size Comfortable

Soft and very colourful, children will adore jumping on these giant cushions, hugging them, putting their head behind the ears, etc.

They develop body awareness, visual discrimination of colours and shapes, touch and motor skills.



Ultra soft and comfortable
giant cushion.
Washable at 86°F.

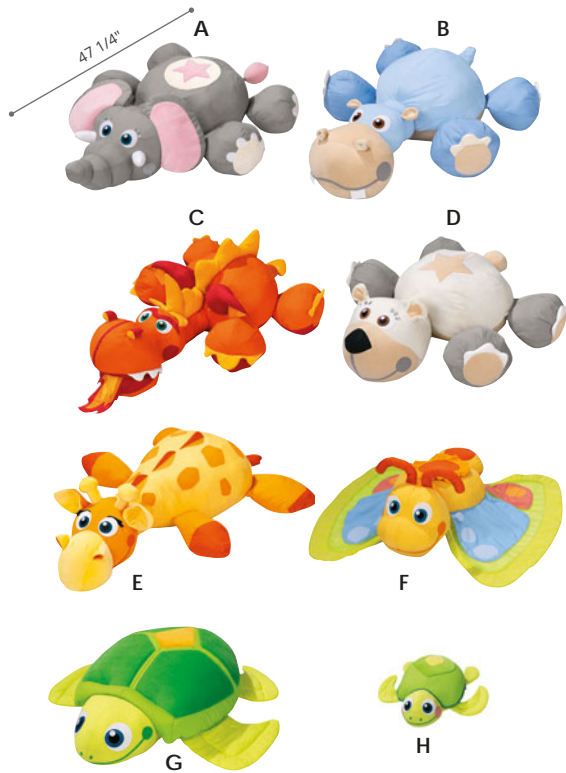

I  Weighted arms to soothe and calm

Doodanimo gives superpowers sensory

GIANT CUSHION Made from POLYESTER FIBRES. Washable at 86 °F (removable cover).
each

A	Lilian the elephant	L: 47 1/4" - W: 35 1/2" - H: 15 3/4".	59 379
B	Sam the hippopotamus	L: 43 1/4" - W: 35 1/2" - H: 15 3/4".	59 380
C	Nick the fantastic dragon	L: 55" - W: 35 1/2" - ridge H: 19 3/4".	59 381
D	Marius the bear	L: 39 1/4" - W: 35 1/2" - H: 15 3/4".	59 382
E	Olaf the giraffe	L: 47 1/4" - W: 35 1/2" - H: 15 3/4".	59 383
F	Zébulon the butterfly	L: 39 1/4" - W: 39 1/4" - H: 11 3/4".	59 385
G	Lulu the tortoise	L: 37 1/2" - W: 33 1/2" - H: 11 3/4".	59 384
H	BABY ANIMAL CUSHION TURTLE	L: 13 3/4" - W: 12 1/2" - H: 4 1/4".	59 618
G + H	GIANT CUSHION Lulu the turtle and her baby	61 606	set



J Contains a heated insert (seed bag/hot water bottle).

K Sensory experiences (visual and auditory).

L Different tactile areas (various fabrics) with a vibrating insert which activates when the tongue is pulled.

From birth **new**
DOODANIMO Washable at 86 °F.
each

I	Ted with weighted arms	L: 22 3/4" - W: 16 1/2" - H: 29 1/4" - Weighted section: 1,3lbs.	67 075
J	Red	L: 46" - W: 39" - H: 2" - Weighted part: 1,3 lbs.	67 227
K	Led	L: 13" - W: 6 1/2" - H: 4 1/4".	67 228
L	Ned	L: 26" - W: 13" - H: 8 1/4".	67 078

SET OF 4 DOODANIMO'S 68 266
pack of 4



Cape costumes

Perfect for little ones!

Very easy to slip on: sleeveless.

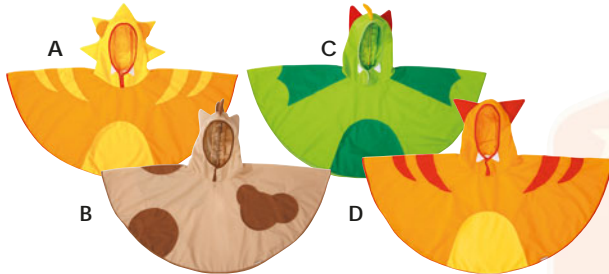

+ washable at 86 °F.
 Fabrics guaranteed free from azo dyes
 (to reduce the risks of allergies).

CAPE COSTUME With our cape costumes, children will be in fancy dress in just a few seconds. The sleeveless cape costume slips on in 2 seconds so children can identify with their favourite character all by themselves. 33 3/4" to 41 1/4" tall. Made from VARIOUS FABRICS. Washable at 86 °F.

A	Lion	52 881	each
B	Horse	52 883	each
C	Dragon	52 884	each
D	Tiger	52 882	each



All our costumes are delivered without accessories.

Complies with toy standards: EN 71 1, 2 and 3

Delivered flat-packed, do-it-yourself installation. Wall fixing screws are not supplied, these depend on your type of wall.

 Screen-printed patterns for greater durability.

 From eco-managed forests

+ 18 months

Activity panels

Create your own early learning wall

Stack, thread, hit, screw, lace, combine, etc.
A host of different activities to develop hand-eye coordination and refine children's movements!

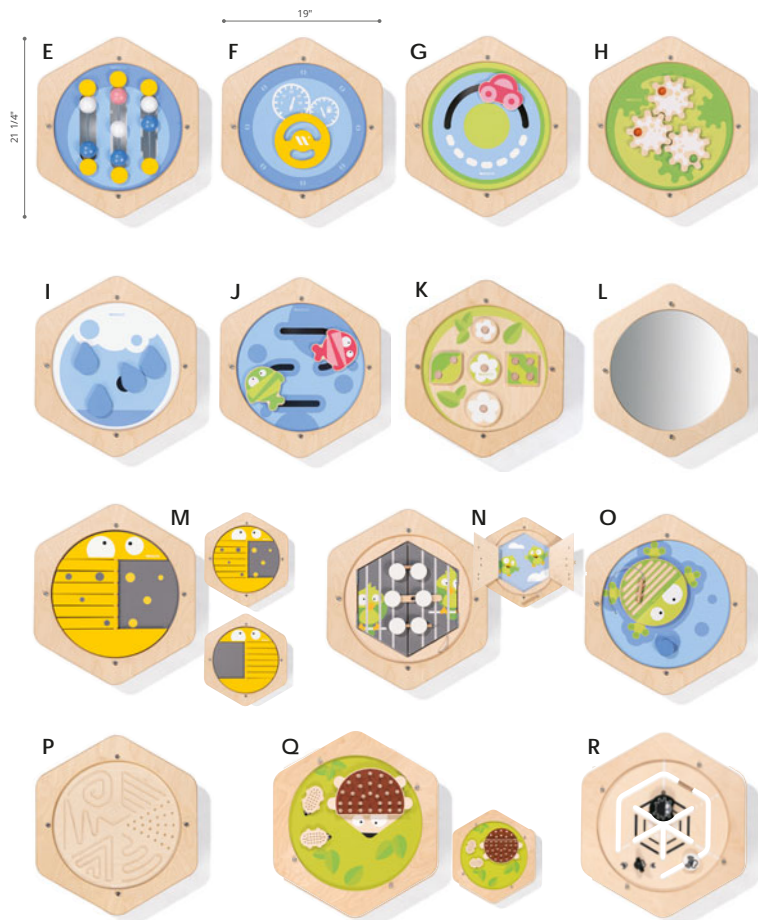

HEXAGON ACTIVITY PANEL The Hexagon activity panel range offers a wide range of activities (abacuses, gears, hide-and-seek, etc.) to design your own sensory stimulation wall depending on the desired number of children. L: 19" - W: 21 1/4" - th: 2 3/4". Made from varnished PLYWOOD. Flat-packed for self-assembly. Wall fixing screws are not supplied, these depend on your type of wall.

E Abacus	51 303	each
F Steering wheel	51 304	
G Cars	51 306	
H Cogs	51 252	

HEXAGON ACTIVITY PANEL MAXI PACK MECHANISMS

60 226	pack of 4	each
---------------	-----------	------

I Water	51 302	
J Fish	51 307	
K Nature shapes	60 224	
L Mirror	51 305	

HEXAGON ACTIVITY PANEL MAXI PACK NATURE

60 227	pack of 4	each
---------------	-----------	------

M Ladybird-Bee	60 223	
N Bird cage	60 225	
O Guiro Frog	60 210	

MANIPULATIONS HEXAGON ACTIVITY PANEL MAXI PACK

63 769	pack of 3	each
---------------	-----------	------

P Digital Graphic Design	60 207	
Q Hedgehog family	62 582	
R The spider	62 584	

DEXTERITY HEXAGON ACTIVITY PANEL MAXI PACK

62 699	pack of 3	
---------------	-----------	--





wesco
 design
1 YEAR GUARANTEE
MADE IN FRANCE
 Supplied with
 an educational booklet.

Impressive size:
14 1/2" x 14 1/2".

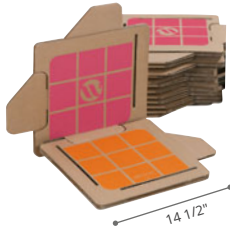

With their large notches, our boards can be assembled quickly to form large, flat surfaces. All the elements from the range are compatible with other pieces and can be placed side by side.



ARCHIBloc PANELS	
L: 14 1/2" - W: 14 1/2" - th: 1/2".	
pack of 14	39 603
pack of 28	39 608
pack of 42	39 612
ARCHIBloc PANELS	54 603

ARCHIBLOC giant construction

+ 3 years

for use under adult supervision

Ultra-resistant:

even to an adult weighing up to 176,4 lbs!

Archiblock cardboard bricks can be used to create many different routes and an infinite number of constructions... Archiblock cardboard bricks can be used to create a range of different constructions by stacking them endlessly. They are very light and safe for children, while remaining extremely solid.



Risk-free:
 hand protection net.
 Double corrugated cardboard.



Recyclable cardboard from eco-managed forests. Designs printed with edible inks.

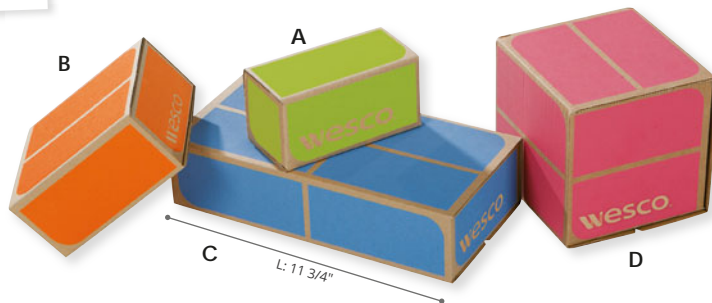

	A ARCHIBloc QUARTER BRICKS	B ARCHIBloc HALF-BRICKS	C ARCHIBloc BRICKS	D ARCHIBloc CUBES
Colours MULTICOLOURED (020)	L: 6" - W: 3" - H: 3".	L: 6" - W: 6" - H: 3".	L: 11 3/4" - W: 6" - H: 3".	L: 6" - W: 6" - H: 6".
pack of 10	51 886	39 623	39 610	39 618
pack of 20	51 934	39 624	39 613	39 619
pack of 40	51 935	39 625	39 614	39 621

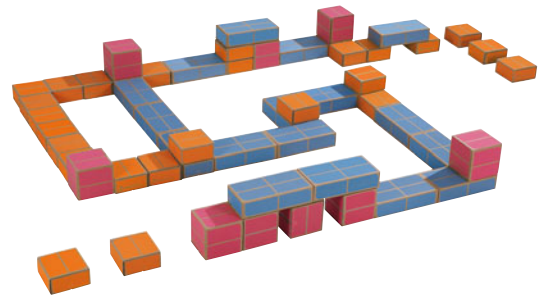

Bricks and panels ARCHIBloc KIT Consists of: 84 panels, 30 quarter bricks, 10 half bricks and 10 bricks.
63 823 set

ARCHIBloc 25 piece KIT Consists of: 15 quarter bricks, 5 half bricks and 5 bricks. Colours MULTICOLOURED (020)
51 937 set

ARCHIBloc 50 piece KIT Consists of: 30 quarter bricks, 10 half bricks and 10 bricks. Colours MULTICOLOURED (020)
51 936 set

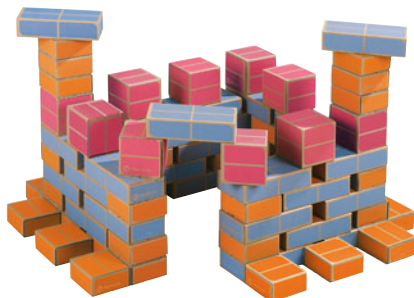

ARCHIBloc maxi obstacle course 50 piece KIT Consists of: 20 bricks, 20 half-cubes and 10 cubes. Colours MULTICOLOURED (020)
39 626 set

ARCHIBloc maxi castle 70 piece KIT Consists of: 40 bricks, 20 half cubes and 10 cubes. Colours MULTICOLOURED (020)
39 630 set

Walkers and ride-on toys

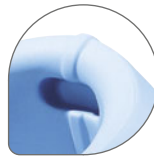

Handle for easy carrying.



Castors for optimal ease of movement.



100% recyclable plastic.

Extremely stable.

+ 9 months

WALKER Babiboost The shape of this walker has been specially designed to encourage baby's first steps. The reassuringly round, gentle shape surrounds and supports the baby when they are beginning to stand up. A wide solid handle makes it easy to pick up. L: 21 1/4" - W: 19" - H: 17". Made from thick POLYETHYLENE. For indoor and outdoor use. Comes assembled. Choice of colours: LIGHT BLUE (057) - LIGHT GREEN (037)

37 932

each

Learning to balance, step by step...



+ 18 months

APIBO PUSHALONG The APIBO moves in all directions and turns entirely around itself. Thanks to its symmetrical shape, it can be used in both directions. L: 24" - W: 11 1/2" - Total H: 10 1/4". Seat H: 8 1/4". Made from thick POLYETHYLENE, washable with water. Indoor use. Comes assembled. Choice of colours: BLUE (002) - ORANGE (007)

41 351

each

Stackable for easy storage.



Ultra-mobile:

turns in every direction!



Silent and flanged wheels for greater safety.



Become aware of your body. Exercise gross motor skills. Encourage autonomy.



From eco-managed forests

+ 10 months

2 year guarantee

WALKER To walk, move toys, transport tools and more. The trolley is an ideal solution to safely discover the market: an ultra-resistant motor skills classic. Designed to encourage independence, you'll love its silent wheels and excellent stability. Fitted wheels with rubber tyres. Sold without fabric container. L: 18 1/2" - W: 13" - H: 17". Made from WOOD. Indoor use. Delivered flat-packed, do-it-yourself installation.

39 649

each



1 to 4 years

Bio-sourced SMALL BEE ROCKER Designed for the youngest children, this rocker has a wide base offering great stability, for hours of safe play ! Stackable for easy storage. L: 25 1/4" - W: 17 3/4" - H: 14 1/4". Made from BIO-SOURCED MATERIAL, washable using a soft cloth in cold soapy water. For indoor and outdoor use.

60 675

each

1 - Firstly, the controlled cultivation of sugar cane which absorbs CO2 and produces oxygen.

2) Sugar cane waste is useful! It's converted into ethanol, a plant-based fuel.

3) Everything can be transformed! Production of an environmentally friendly polyethylene from ethanol.



*Emmanuelle Langlois,
Psychomotor Therapist.*

The rocking movements stimulate the vestibular system and steady the gaze during the movement, which is essential to balance, especially when learning to walk.

Yes
to bio-sourced materials!

100% recyclable
Low GHG emissions



A

Secure seat.
Bucket seat for greater safety.

 **wesco**
design

3 YEAR GUARANTEE

MADE IN FRANCE

Complies with toy standards: EN 71 1, 2 and 3

Phthalate-free.

 **100% recyclable.**

Rockers

A 1 to 3 years

BABY ROCKER Designed for the very young, this baby rocker even supports those for whom sitting is not yet easily achieved. L: 35 1/2" - W: 19 1/4" - H: 19 3/4". Seat H: 7 3/4". Made from thick POLYETHYLENE. washable using a soft cloth in cold soapy water. For indoor and outdoor use. Choice of colours: LIGHT BLUE (057) - LIGHT GREEN (037)

33 447

each

B 18 months to 3 years

BULL ROCKER With the bull rocker, children discover the joy of practising rodeo. The rocker oscillates back and forth and back again, allowing children to acquire and improve their balance on the saddle. L: 29 1/2" - W: 13 3/4" - H: 20 3/4". Seat H: 11 3/4". Made from thick POLYETHYLENE. washable using a soft cloth in cold soapy water. For indoor and outdoor use. Choice of colours: BLUE (002) - LIGHT GREEN (037) - ORANGE (007)

49 435

each

C 1 to 3 years

2-SEAT BABY SEESAW/BRIDGE A multifunctional game to help develop a child's motor skills. In the rocking position, the two seats provide optimal and secure support. In the bridge/tunnel position, children can climb, hide, crawl... L: 46 3/4" - W: 19 3/4" - H: 22 1/2". Made from thick POLYETHYLENE. For indoor and outdoor use. Choice of colours: LIGHT BLUE (057) - LIGHT GREEN (037) - LIGHT ORANGE (164)

54 230

each

D 1 to 4 years

THREE-SEATER ROCKER With its stable base, this seesaw ensures complete safety. This rocker with rounded design is suitable for one, two or three children. L: 46 1/2" - W: 19" - H: 18 1/2". Seat H: 9 3/4". Made from thick POLYETHYLENE. washable using a soft cloth in cold soapy water. For indoor and outdoor use. Choice of colours: BLUE (002) - LIGHT GREEN (037) - ORANGE (007) - RED (011)

00 422

each



B



C



D

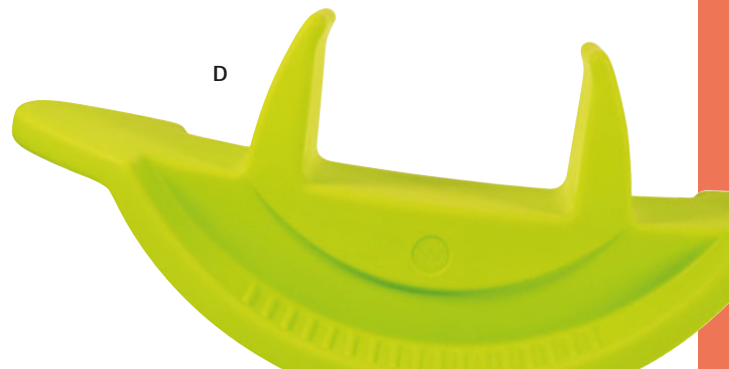

Mats for the very young

From birth

A sensory activity space on the floor or wall!

These mats can be used individually or joined together using hook and loop fastener in order to create play areas to protect children from falls.

+ **Great comfort and maximum safety.**
Easy to clean: the coated fabric can be gently cleaned with a cloth or sponge, in cold soapy water or with our cleaning product.
 With their side velcro strips, you can fix them together in a vertical or horizontal position. Polyether foam, density 52,9 lbs / m³, covered with a jersey-lined vinyl cover to **absorb shocks** (non-slip back).



With their side velcro strips, you can fix them together in a vertical or horizontal position.

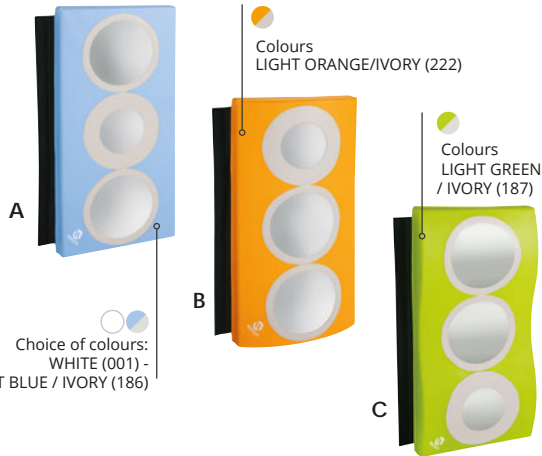

BABY WALL MAT With mirrors Completely safe synthetic mirrors. L: 37 3/4" - W: 19". Made from flexible POLYETHER FOAM. Washable with water. Indoor use. Fitted with an anti-slip base. Comes with 2 velcro strips so that it may be attached to the wall.

A Basic model	L: 37 3/4" - W: 19" - th: 2".	33 554	each
B 1 hump	L: 37 3/4" - W: 19" - th: 4 1/4".	33 555	each
C 2 humps	L: 37 3/4" - W: 19" - th: 3 3/4".	33 558	each

BABY WALL MAT MAXI PACK With mirrors	61 334
	pack of 3



wesco design
3 YEAR GUARANTEE
MADE IN CANADA
 Complies with standard EN 1021-1 and 2: flammability of filled furnishings
 Phthalate-free.
 Comes with 2 velcro strips so that it may be attached to the wall.

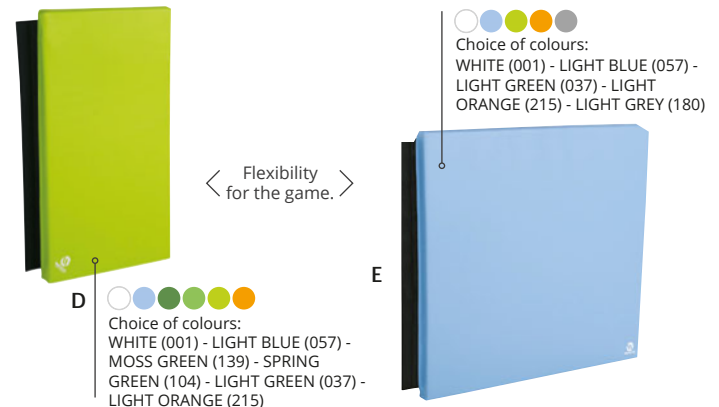

BABY WALL MATS D: 2". Made from Soft POLYETHER FOAM. Washable with water. Indoor use. Can also be used on the ground. Fitted with an anti-slip base. Comes with 2 Velcro wall strips that you can attach yourself.

D 37 3/4 x 19"	33 486	each
E 37 3/4 x 37 3/4"	51 873	

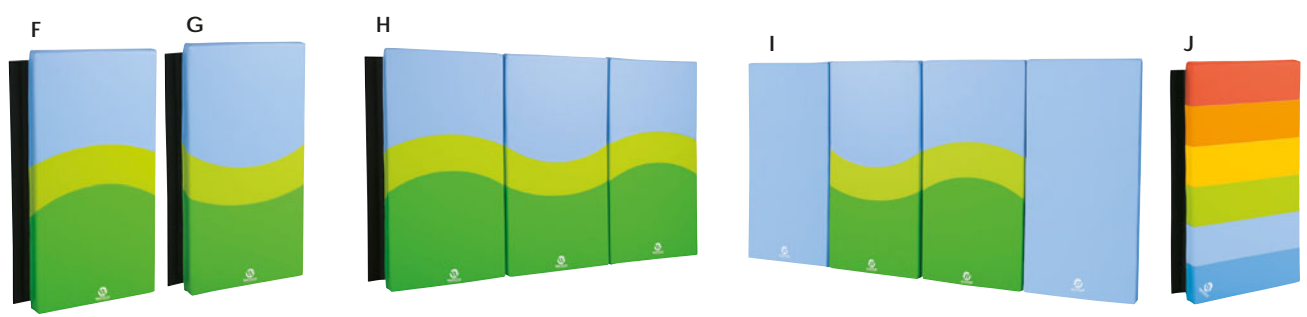

WAVE ACTIVITY MAT L: 37 3/4" - W: 19" - th: 2".
 Made from flexible POLYETHER FOAM. Washable with water. Indoor use. Fitted with an anti-slip base. Comes with 2 velcro strips so that it may be attached to the wall. Colours LIGHT BLUE/GREEN (110)

F High wave	33 488
G Low wave	33 489

H **MAXI PACK 3 BABY MATS**
 2 high wave Baby mats 51 851
 and 1 low wave Baby mat set

I **MAXI PACK of 4 BABY MATS**
 1 high wave BABY MAT, 51 852
 1 low wave BABY MAT set
 and 2 plain BABY MATS.

J **TINY TOT ACTIVITY WALL MAT** Rainbow
 L: 37 3/4" - W: 19" - Th. 2". Made from flexible POLYETHER FOAM. washable with water. Indoor use. Fitted with an anti-slip base. Comes with 2 velcro strips so that it may be attached to the wall.
 66 638 each



 Bio-sourced
VINYL FABRIC.

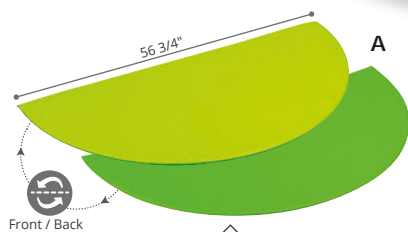

Reversible mat
Compatible with all our age first stage
modules (Tiny Tot modules, gymmodules,
ball pools, babytapis walls...)

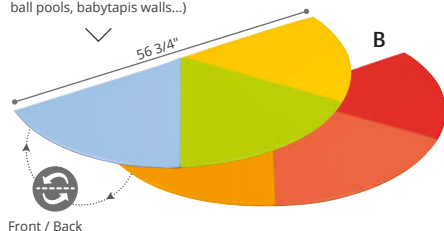

A  **PLAIN DOUBLE-SIDED SEMI CIRCULAR MAT** This reversible mat with two sides in different colours can be made into a large circle by placing it alongside another mat. Perfect surface where toddlers can play, lie down, sit down and roll over! L: 56 3/4" - W: 28 1/4" - Th: 3/4". Made from 1,5 lbs/ft³ density POLYETHER FOAM covered in a jersey-based VINYL FABRIC. washable with water. Indoor use. Choice of colours: GREEN/LIGHT GREEN (169) - BLUE/LIGHT BLUE (218) - ORANGE/LIGHT ORANGE (220)

45 426 each

B **TRI-COLOURED DOUBLE SIDED SEMI CIRCULAR MAT** This reversible mat with two tricolour sides can be made into a large circle by placing it alongside another mat. Perfect surface where toddlers can play, lie down, sit down and roll over! L: 56 3/4" - W: 28 1/4" - Th: 3/4". Made from 1,5 lbs/ft³ density POLYETHER FOAM covered in a jersey-based VINYL FABRIC. washable with water. Indoor use.

66 634 each



PLAIN MAT Children's play mats: ideal for motor skill activities! Made from 1,9 lbs/ft³ density POLYURETHANE FOAM covered with a jersey-lined VINYL FABRIC. Washable with water. Choice of colours: BLUE (214) - TEAL (223) - LICHEN (122) - LIGHT GREEN (037) - LIGHT ORANGE (215) - SAND (135)

C L: 51 1/4" - W: 25 1/2" - Th: 3/4".	45 431
D L: 51 1/4" - W: 51 1/4" - Th: 3/4".	45 432
E L: 78 3/4" - W: 51 1/4" - Th: 3/4".	45 433

each

PLAIN MAT 51 1/4 x 25 1/2" bio-based fabric Choice of colours: GREEN (008) - NATURAL (016)

F L: 51 1/4" - W: 25 1/2" - Th: 3/4".	60 085
--	--------

each

G **4 COLOUR ASYMMETRICAL MAT** This four-colour mat offers a large early learning surface where toddlers can play, lie down, sit down and roll over! Does not bend. L: 51 1/4" - W: 51 1/4" - Th: 3/4". Made from 1,9 lbs/ft³ density POLYETHER FOAM covered in a jersey-lined VINYL FABRIC. washable with water. Indoor use. Fitted with an anti-slip base.

66 633 each



2 YEAR GUARANTEE

MADE IN CANADA

Complies with standard EN 1021-1 and 2: flammability of filled furnishings

Phthalate-free.

Mats for the very young, 3/4" thick

From birth

Lightweight, *soft* and comfy.

+ Large playing surface.
Easy care.
Ultra-resistant.

Bio-sourced
VINYL FABRIC.

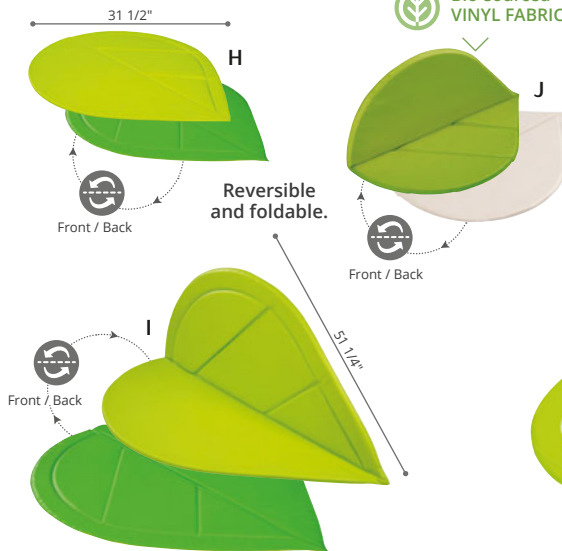

K

Safe
synthetic
mirror.



L



M

DOUBLE-SIDED LEAF MAT This reversible mat with two different sides can be used on the floor or folded against a wall to protect children. Perfect surface where toddlers can play, lie down, sit down and roll over! Made from 1,5 lbs/ft³ density POLYETHER FOAM covered in a jersey-based VINYL FABRIC. Washable with water.

H	SMALL	L: 31 1/2" - W: 31 1/2" - th: 3/4".	57 295
I	LARGE	L: 51 1/4" - W: 51 1/4" - th: 3/4".	45 429
J	SMALL LEAF MAT Bio-sourced fabric	L: 31 1/2" - W: 31 1/2" - th: 3/4".	60 086

NATURE MIRROR MAT Both decorative and amusing, these mirror mats have an excellent play surface for toddlers. With the large mirror, children can also stimulate their visual sense by paying attention to themselves. A new discovery! Made from 1,5 lbs/ft³ density POLYETHER FOAM covered in a jersey-based VINYL FABRIC. Washable with water. Indoor use.

			each
K	Aquaic	L: 47 1/4" - W: 45 3/4" - Th: 3/4".	37 859
L	Plants	L: 47 1/4" - W: 33 3/4" - Th: 3/4".	37 861
M	Floral	Ø 47 1/4" - Th: 3/4".	37 863
MAXI PACK NATURE MIRROR MAT			50 231
			pack of 3

MOSAIC

early years mat,

1 1/2" thick

 **wesco**
design

2 YEAR GUARANTEE

MADE IN CANADA

Phthalate-free.

From birth



Highly
absorbent

Compatible sizes to increase
the number of layout
possibilities!

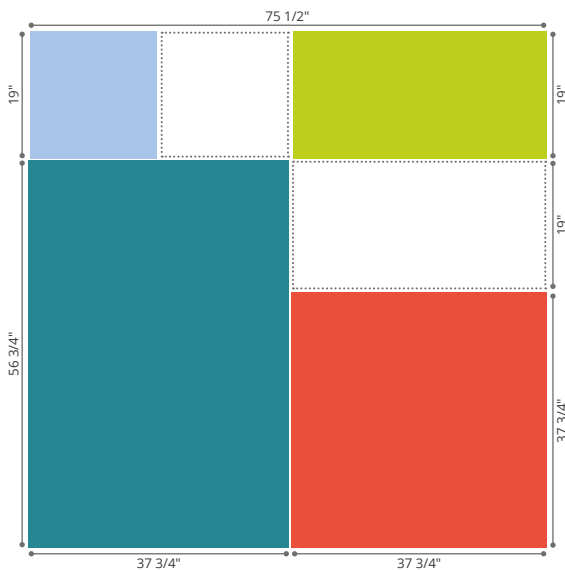

Mosaic mats Th: 1 1/2". Made from 1,5 lbs/ft³ density POLYETHER FOAM covered in a jersey-based VINYL FABRIC. Washable using a soft cloth in cold soapy water. Indoor use. Fitted with a non-slip base and velcro strips on all 4 sides.

19 x 19" Choice of colours: WHITE (001) - LIGHT BLUE (057) - TEAL (223) - LICHEN (122) - LIGHT GREEN (037) - YELLOW (014) - ORANGE (216) - SAND (135) - IVORY (138)

26 780 each

37 3/4 x 19" Choice of colours: WHITE (001) - LIGHT BLUE (057) - TEAL (223) - LICHEN (122) - LIGHT GREEN (037) - YELLOW (014) - ORANGE (216) - SAND (135) - IVORY (138)

26 781 each

37 3/4 x 37 3/4" Thickness: 1 1/2". Choice of colours: WHITE (001) - LIGHT BLUE (057) - TEAL (223) - LICHEN (122) - LIGHT GREEN (037) - YELLOW (014) - LIGHT ORANGE (215) - ORANGE (216) - IVORY (138)

26 782 each

56 3/4 x 37 3/4" Th: 1 1/2". Choice of colours: WHITE (001) - LIGHT BLUE (057) - TEAL (223) - LICHEN (122) - LIGHT GREEN (037) - YELLOW (014) - ORANGE (216) - IVORY (138)

26 783 each



**Soft
and Flexible**



Mosaic CONTAINER
L: 19" - W: 19" - H: 9 1/2"

39 567 each



Thickness: 1 1/2" = maximum comfort.

Made from 1,5 lbs/ft3 density foam, and covered in a jersey-lined vinyl fabric.

Easy to clean: The fabric is easy to clean with soapy water

The Velcro strips on all four sides ensure they stay in place.

Non-slip base.

Numerous layout possibilities for the kits:

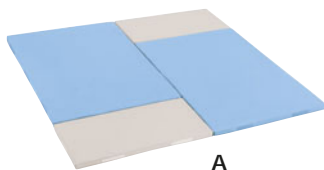
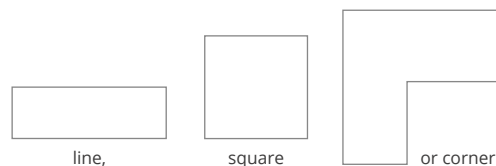

A

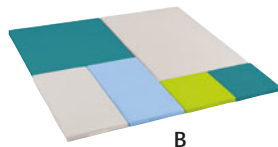

B

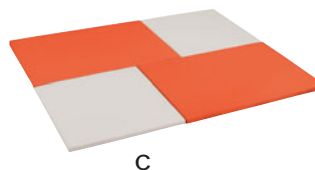

C

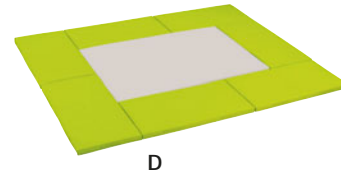

D



A 4 SQUARE Mosaic MATS KIT Consists of: 2 mats 56 3/4 x 37 3/4" and 2 mats 37 3/4 x 19". Made from 1,5 lbs/ft3 density POLYETHER FOAM covered in a jersey-based VINYL FABRIC. washable using a soft cloth in cold soapy water. Indoor use. Fitted with an anti-slip base and hook and loop fastener on all 4 sides. Choice of colours: LIGHT BLUE / IVORY (186) - TEAL/IVORY (226) - LICHEN/IVORY (227) - LIGHT GREEN / IVORY (187) - YELLOW/IVORY (209) - ORANGE/IVORY (225)

39 766 set

B 6 SQUARE Mosaic MATS KIT Consists of: 1 mat 56 3/4 x 37 3/4", 1 mat 37 3/4 x 37 3/4", 2 mats 37 3/4 x 19" and 2 mats 19 x 19". Floor space L: 56 3/4" - W: 56 3/4", washable using a soft cloth in cold soapy water. Indoor use. Fitted with an anti-slip base and hook and loop fastener on all 4 sides. Choice of colours: MULTICOLOURED (020) - LIGHT GREEN / IVORY (187)

66 695 set

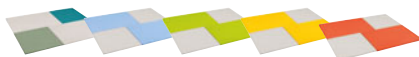

C 4 RECTANGULAR Mosaic MATS KIT Consists of: 2 mats 56 3/4 x 37 3/4" and 2 mats 37 3/4 x 37 3/4". Made from 1,5 lbs/ft3 density POLYETHER FOAM covered in a jersey-based VINYL FABRIC. washable using a soft cloth in cold soapy water. Indoor use. Fitted with an anti-slip base and hook and loop fastener on all 4 sides. Choice of colours: MULTICOLOURED (020) - LIGHT BLUE / IVORY (186) - LIGHT GREEN / IVORY (187) - YELLOW/IVORY (209) - ORANGE/IVORY (225)

39 768 set

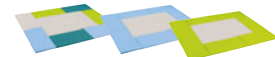

D 8 RECTANGULAR Mosaic MATS KIT Consists of: 1 mat 56 3/4 x 37 3/4" and 7 mats 19 x 37 3/4". Made from 1,5 lbs/ft3 density POLYETHER FOAM covered in a jersey-based VINYL FABRIC. washable using a soft cloth in cold soapy water. Indoor use. Fitted with an anti-slip base and hook and loop fastener on all 4 sides. Choice of colours: MULTICOLOURED (020) - LIGHT BLUE / IVORY (186) - LIGHT GREEN / IVORY (187) - YELLOW/IVORY (209) - ORANGE/IVORY (225)

39 769 set

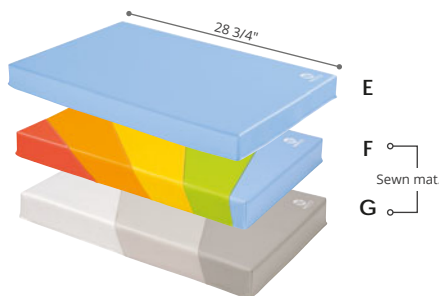

			each
E Rectangular		LIGHT BLUE (057) - LIGHT ORANGE (215)	04 555
F Rainbow		MULTICOLOURED (020)	66 385
G Tricolour		GREEN (008) - GREY (006)	66 387

MADE IN CANADA



B 3 soft mirrors sewn to the mat



A BASIC FLOOR MAT 48" x 48" x 1". Colours BLUE (214)

07 004 each \$173.00

B ACTIVITY-MIRROR MAT 51" x 51" x 1". Colours MULTICOLOURED (020)

07 005 each \$195.00

C COLOURED FLOOR MAT 48" x 48" x 1". Colours MULTICOLOURED (020)

07 003 each \$178.00

D CIRCLES FLOOR MAT 48" x 48" x 1". Colours MULTICOLOURED (020)

07 001 each \$182.00



E



F



G



E DELUXE REST MAT 48" x 24" x 2". Choice of colours: BLUE (002) - GREEN (008) - YELLOW (014) - RED (011)

01 012 each

01 2-4 pack of 4

DELUXE MINI-REST MAT 45" x 23" x 2". Choice of colours: BLUE (002) - GREEN (008) - YELLOW (014) - RED (011)

01 016 each

01 6-4 pack of 4

F A, B, C, D Floor Mat 48" x 48" x 1". Colours MULTICOLOURED (020)

07 002 each

G 6 Side Mirror Block 4 3/4" x 28 1/4" opened. Each side is 4 3/4" x 4 3/4". Colours MULTICOLOURED (020)

07 006 each

Ball pools



2-YEAR GUARANTEE
except ball

Complies with standard
EN 1021-1 and 2:
flammability of filled
furnishings

Phthalate-free.

+ 18 months
for use under adult supervision

Children love jumping into, playing and relaxing in our ball pools. Through play, they become aware of their bodies, develop motor skills and learn to play together.



Resistant:

Highly resistant vinyl fabric.

1,5 lbs/ft³ foam: long-lasting and durable, will not lose its shape.

Hygienic: the vinyl fabric is easy to clean with either a soft cloth or sponge and cold soapy water. Each ball pool has a base mat.

Quick to install: Each component is fitted with Velcro strips from top to bottom (except the "Lotus" range which has zip fastenings).



Inclusive SOLUTIONS

Ball pools have benefits that are therapeutic, relaxing and sensory, with a kinaesthetic aspect (position and movement of the various parts of the body). Ball pools also allow development in an unstable but safe environment.

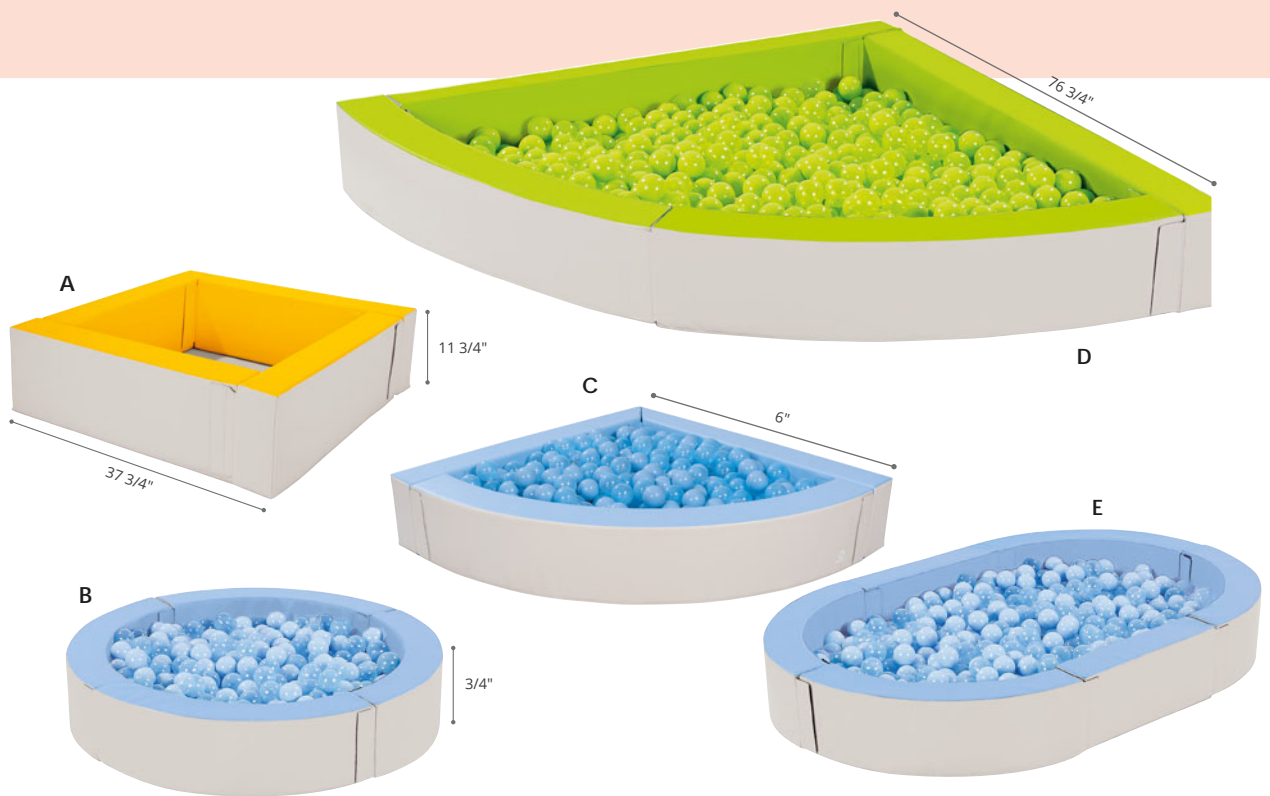

			With balls set	Without balls set	
A	Basic MINI BALL POOL	4 items, 1 base mat and approximately 120 transparent balls. L: 37 3/4" - W: 37 3/4" - H: 11 3/4" - th: 4 3/4".	Choice of colours: LIGHT GREY / IVORY (181) - LIGHT BLUE / IVORY (186) - LIGHT GREEN / IVORY (187) - YELLOW/IVORY (209)	61 257	54 122
B	Basic JACUZZI BALL POOL	4 quarter circle pieces, 1 round base mat, 250 opaque balls and 250 transparent balls. Ø 56 3/4" - H: 11 3/4" - th: 6".	Choice of colours: LIGHT GREY / IVORY (181) - LIGHT BLUE / IVORY (186) - LIGHT GREEN / IVORY (187) - YELLOW/IVORY (209)	61 258	61 244
C	Basic SMALL CORNER BALL POOL	3 items, 1 base mat, 250 transparent balls and 250 opaque balls. Ext. radius: : 53 1/4" - H: 11 3/4" - th: 6".	Choice of colours: LIGHT BLUE / IVORY (186) - LIGHT GREEN / IVORY (187) - YELLOW/IVORY (209)	61 265	60 229
D	Basic LARGE CORNER BALL POOL	4 items, 1 base mat, 250 opaque balls and 500 transparent balls. Ext. radius: : 76 3/4" - H: 11 3/4" - th: 6".	Choice of colours: LIGHT BLUE / IVORY (186) - LIGHT GREEN / IVORY (187) - YELLOW/IVORY (209)	61 266	00 873
E	Basic LARGE BATH BALL POOL	4 quarter circle pieces, 2 rectangular pieces, 1 oval base mat, 500 opaque balls and 250 transparent balls. L: 85" - W: 56 3/4" - H: 11 3/4" - th: 6".	LIGHT BLUE / IVORY (186)	61 268	61 247



TRANSPARENT BALLS x250
 Ø 3 1/4".

34 293 pack of 250

Choice of colours:
 WHITE (001) - BLUE (002) - GREEN (008) - YELLOW (014) -
 ORANGE (007) - MULTICOLOURED (020)

OPAQUE BALLS x250
 Ø 3 1/4".

34 292 pack of 250

Net attached to each box to make washing and carrying the balls easier.



EXTRA NET FOR BALLS

21 999 each





STEP AND SLIDE
Cosy Large Bath Ball Pool
74 3/4 x 74 3/4"
 L: 51 1/4" - W: 23 1/2" - H: 19 3/4"
 Step: H: 6 1/2" - D: 6 1/2"
 Arch W: 7 3/4" - H: 14 1/2".

01 314 each

COSY Large ball pools



B

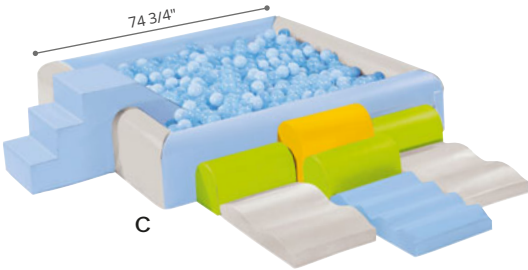

C

BLOCMODULES
Four steps for Cosy Giant Ball Pool
 L: 35 1/2" - W: 23 1/2" - H: 23 1/2".
 Step: H: 6" - D: 8 3/4".

01 317 each

Total height
22 1/4"

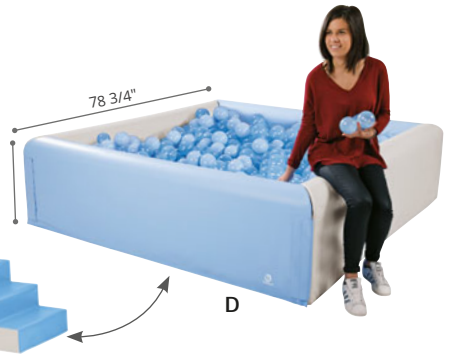

D

With balls **Without balls**
 set set

A	Cosy LARGE BATH BALL POOL	4 items, 1 base mat, 500 opaque balls and 500 transparent balls. Ideal ball volume: 1000 balls. L: 74 3/4" - W: 74 3/4" - H: 14 1/2" - th: 7 3/4".	Choice of colours: WHITE (001) - LIGHT BLUE / IVORY (186) - LIGHT GREEN / IVORY (187) - YELLOW/IVORY (209)	61 270	00 856
B	Cosy CLIMBING RAMP BALL POOL	1 dual-coloured pool, 1 step bridge, 1 large arch, 1 small arch, 500 opaque balls and 500 transparent balls. Ideal ball volume: 1000 balls. L: 94 1/2" - W: 93 3/4" - H: 19 3/4". Pool: L: 74 3/4" - W: 74 3/4" - H: 14 1/2" - th: 7 3/4".		61 271	61 251
C	Cosy ADVENTURE BALL POOL	1 dual-coloured pool, 1 step bridge, 1 large bump, 3 small bumps, 2 two-wave mats, 1 four-wave mat, 500 opaque balls and 500 transparent balls. Ideal ball volume: 1000 balls. L: 94 1/2" - W: 122" - H: 19 3/4". Pool: L: 74 3/4" - W: 74 3/4" - H: 14 1/2" - th: 7 3/4".		61 272	61 252
D	Cosy GIANT BALL POOL	4 items, 1 base mat, 1000 opaque balls and 1250 transparent balls. Ideal ball volume: 2250 balls. L: 78 3/4" - W: 78 3/4" - H: 22 1/4" - th: 7 3/4".	Choice of colours: LIGHT BLUE / IVORY (186) - LIGHT GREEN / IVORY (187)	61 273	42 479



LOTUS ball pools

Ideal for small spaces!

A ball pool and play mat in one!



F

E



19 3/4"

28 1/4"

Rest area

Motor skills area

Safe area (use against a wall)

With balls set Without balls set

E	Lotus CORNER BALL POOL 1 pool, 1 base mat and approximately 120 transparent balls. Ideal ball volume: 120 balls. L: 28 1/4" - W: 28 1/4" - H: 11 3/4" to 19 3/4" - th: 1 1/2".	Choice of colours: LIGHT GREY / IVORY (181) - LIGHT BLUE / IVORY (186) - LIGHT GREEN / IVORY (187) - YELLOW/IVORY (209)	61 274	54 121
F	Lotus WALL BALL POOL 1 pool, 3 x 4-wave mats, 2 corner mats and approximately 120 transparent balls. Ideal ball volume: 120 balls. L: 66 1/4" - W: 47 1/4" - H: 19" - th: 1 1/2".	Colours LIGHT BLUE (057)	61 275	61 254



Choice of colours:
 WHITE (001) - BLUE (002) - GREEN (008) - YELLOW (014) - ORANGE (007) - RED (011)



TRANSPARENT BALLS x120
 Ø 3 1/4".

54 898 pack of 120



OPAQUE BALLS x120
 Ø 3 1/4".

54 897 pack of 120

Net attached to each box to make washing and carrying the balls easier.



EXTRA NET FOR BALLS

21 999 each



Ø 3 1/4".



A wide range of colours!



wesco
design

2 YEAR GUARANTEE

MADE IN CANADA

Complies with standard EN 1021-1 and 2: flammability of filled furnishings

Complies with standard NFS 54-300 : motor activity safety

Phthalate-free.

TINY TOT Modules range

1 to 3 years
for use under adult supervision

Children need movement!

Quality first!

Crawl, climb, slide, balance...

Children can move around our courses in complete safety, designed to withstand thousands of children!

New Mini Tiny Tot modules

Especially for small spaces



Very resistant vinyl fabric, easy to clean.

1,5 lbs/ft3 foam: long-lasting and durable, will not lose its shape.

+ **Firm, comfortable foam:**
1,5 lbs/ft3 density polyether foam for greater longevity over time: does not sag.

Hygienic:
the vinyl fabric is easy to clean with either a soft cloth or sponge and cold soapy water.

Very strong fabric:
Vinyl fabric on a jersey support, stitched all round with extra strong nylon thread. This covering does not lead to friction burns.

Highly-resistant stitching:
All our modules are sewn, with no zip fastenings, to avoid injuring children. Our "embroidered" stitching seals the modules, and prevents children from getting inside them.



Can hold up to 120 balls.

MINI TINY TOT module KIT Diving Consists of:
 1 pool with balls, 1 two-step module, 1 brick, 2 slopes,
 1 corner and 1 cube.
68 930 set



Two steps
 L: 11 3/4" -
 W: 11 3/4" - H: 6".



Brick
 L: 11 3/4" -
 W: 6" - H: 3".



Corner
 L: 11 3/4" -
 W: 11 3/4" - H: 6".



Cube
 L: 6" -
 W: 6" - H: 6".



Slope
 L: 11 3/4" -
 W: 11 3/4" - H: 6".



Pool
 L: 28 3/4" -
 W: 28 3/4" - H: 8 3/4".

MINI Tiny Tot modules
JERSEY-lined vinyl fabric

● ●
67 295
 each

● ●
67 297
 each

● ●
67 298
 each

● ●
67 299
 each

● ●
67 301
 each

● ●
68 907
 each

Choice of colours: SPRING GREEN (104) -
 LICHEN (122) - IVORY (138)

MINI Tiny Tot modules
BIO-BASED COTTON-lined
vinyl fabric

● ●
67 303
 each

● ●
67 304
 each

● ●
67 305
 each

● ●
67 306
 each

● ●
67 307
 each

Colours NATURAL (016)

new

Mini size, big effect!

A smaller version of our Tiny Tot modules, the MINIS have been specially designed to fit small spaces or to quickly set up a motor skills course in a multi-purpose area!



for small spaces



This equipment for developing motor skills is used for supervised educational activities, free expression or under the guidance of qualified professionals.

The kit's parts do not attach to each other.

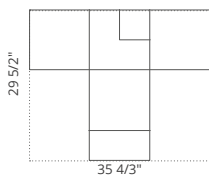

MINI TINY TOT module KIT Nature Consists of: 1 brick, 1 corner, 2 slopes, 1 cube and 1 two-step. Side: 11 3/4" - H: 17 3/4".

67 309

set



Biosourced materials.
Oeko-Tex.

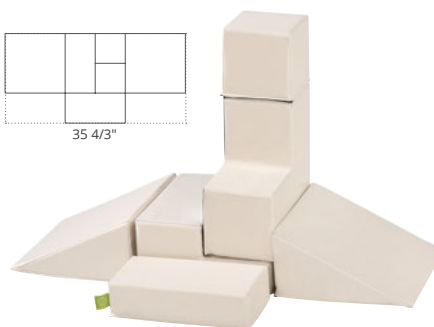
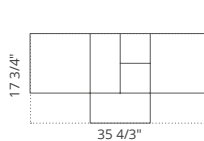

MINI TINY TOT module KIT In bio-based fabric Consists of: 1 two-step, 1 brick, 1 corner, 1 cube and 2 slopes. Side: 11 3/4" - H: 17 3/4".

67 311

set



1 to 3 years
Tiny Tot module Walking aid
 It is scientifically proven that we can help babies' intellectual development by guiding them as from their very first crawling attempts. Through stimulation using a variety of techniques (voice, sounds, objects, etc.) adults attract infants' attention and motivate them to move using all 4 limbs. For each component: L: 27 1/2" - W: 19 3/4" - th: 5 to 6". Made from VINYL COVERS. Indoor use. Fitted with an anti-slip base. Colours LIGHT GREEN (037)

58 921 set



TINY TOT MODULES range

Vibrant colours

A mix of warm shades stimulating creativity, energy and sensory awakening and soothing and reassuring colours to create a world of relaxed stimulation.

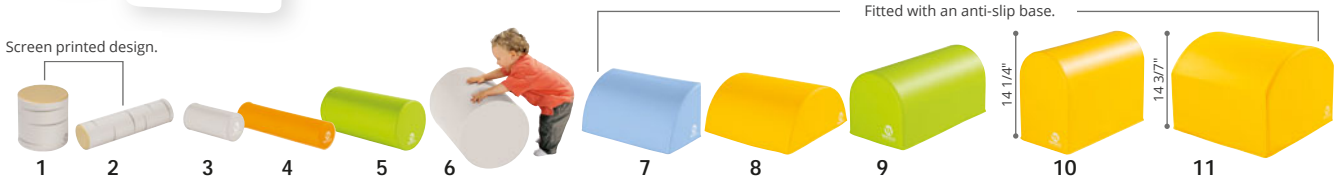

Tiny Tot module Made from 1,5 lbs/ft³ density POLYETHER FOAM covered in a jersey-lined VINYL FABRIC.

					each
1	Birch cylinder Ø 9 1/2"	L: 9 1/2".	●	IVORY (138)	66 419
2	Birch cylinder Ø 4 3/4"	L: 19".	●	IVORY (138)	66 420
3	Small roller Ø 4 3/4"	L: 9 1/2".	●	IVORY (138)	33 618
4	Cylinder Ø 4 3/4"	L: 19".	○ ●	WHITE (001) - LIGHT ORANGE (215)	04 500
5	Cylinder Ø 9 1/2"	L: 19".	●	LIGHT GREEN (037)	04 501
6	Cylinder Ø 14 1/4"	L: 19".	●	IVORY (138)	04 502
7	Quarter moon	L: 19" - Radius: 9 1/2".	●	LIGHT BLUE (057)	04 512
8	Half moon	Side: 19" - H: 9 1/2".	●	YELLOW (014)	04 553
9	Small bump	L: 19" - W: 9 1/2" - H: 9 1/2".	● ● ●	LIGHT BLUE (057) - LIGHT GREEN (037) - IVORY (138)	04 552
10	Large bump	L: 19" - W: 9 1/2" - H: 14 1/4".	● ● ●	YELLOW (014)	04 551
11	Hill	Side: 19" - H: 14 1/4".	● ● ●	YELLOW (014)	04 510

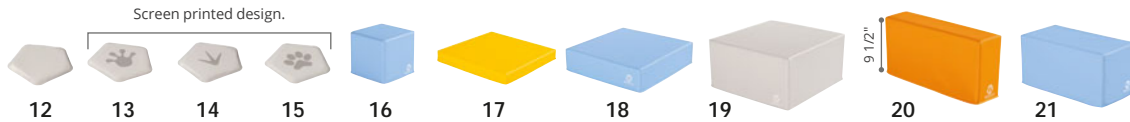

Tiny Tot module Made from 1,5 lbs/ft³ density POLYETHER FOAM covered in a jersey-lined VINYL FABRIC. Fitted with an anti-slip base.

					each
12	Plain tile	L: 11 1/2" - W: 11 1/2" - th: 3/4".	●	IVORY (138)	66 415
13	Frog tile	L: 11 1/2" - W: 11 1/2" - th: 3/4".	●	IVORY (138)	66 417
14	Hen tile	L: 11 1/2" - W: 11 1/2" - th: 3/4".	●	IVORY (138)	66 416
15	Dog tile	L: 11 1/2" - W: 11 1/2" - th: 3/4".	●	IVORY (138)	66 418
16	Small cube	Side: 9 1/2".	● ● ● ●	LIGHT BLUE (057)	04 506
17	Th: 2 1/4"	L: 19" - W: 19" - H: 2 1/4".	● ● ● ● ●	LIGHT BLUE (057) - LIGHT GREEN (037) - YELLOW (014) - IVORY (138)	61 997
18	Th: 4 3/4"	L: 19" - W: 19" - th: 4 3/4".	● ● ● ● ●	LIGHT BLUE (057) - LIGHT GREEN (037) - LIGHT ORANGE (215)	61 996
19	Half-cube	Side: 19" - H: 9 1/2".	● ● ● ●	IVORY (138)	04 504
20	Half-brick	L: 19" - W: 4 3/4" - H: 9 1/2".	● ● ● ●	LIGHT ORANGE (215)	04 508
21	Brick	L: 19" - W: 9 1/2" - H: 9 1/2".	● ● ● ●	LIGHT BLUE (057)	04 507

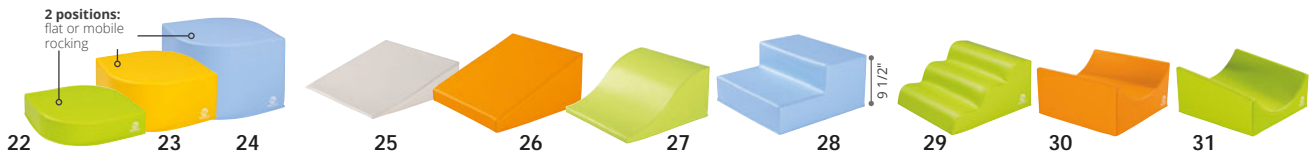

Tiny Tot module Made from 1,5 lbs/ft³ density POLYETHER FOAM covered in a jersey-lined VINYL FABRIC. Fitted with an anti-slip base.

					each
22	Sheet H: 4 3/4"	Side: 19".	●	LIGHT GREEN (037)	66 411
23	Sheet H: 9 1/2"	Side: 19".	●	YELLOW (014)	66 412
24	Sheet H: 14 1/4"	Side: 19".	●	LIGHT BLUE (057)	66 413
25	Small incline	Side: 19" - H: 4 3/4".	● ●	LIGHT BLUE (057) - IVORY (138)	04 513
26	Trapezium	Side: 19" - H: 9 1/2".	● ●	LIGHT ORANGE (215)	04 514
27	Soft wave	Side: 19" - H: 9 1/2".	● ●	LIGHT GREEN (037)	04 519
28	Two steps	Side: 19" - th: 9 1/2". Step: D: 9 1/2".	● ●	LIGHT BLUE (057)	04 515
29	Climbing slope	Side: 19" - H: 9 1/2".	● ●	LIGHT GREEN (037)	66 410
30	Valley	Side: 19" - H: 9 1/2".	● ●	LIGHT ORANGE (215)	04 511
31	Slide	Side: 19" - H: 9 1/2".	● ●	LIGHT GREEN (037)	04 011

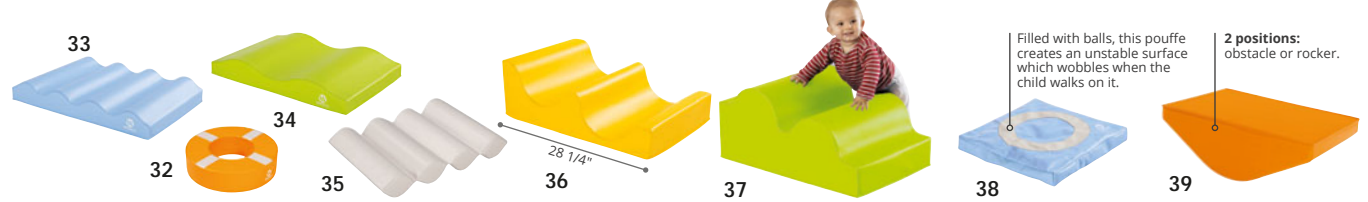

Tiny Tot module Made from 1,5 lbs/ft³ density POLYETHER FOAM covered in a jersey-lined VINYL FABRIC. Fitted with an anti-slip base.

					each
32	Buoy	Ø ext: 19" - Ø int: 9 1/2" - H: 4 3/4".	●	LIGHT ORANGE (215)	66 414
33	Four waves mat	L: 28 1/4" - W: 19" - th: 4".	● ●	LIGHT BLUE (057) - LIGHT GREY (180)	04 523
34	2 waves mat	L: 28 1/4" - W: 19" - th: 4".	● ●	LIGHT GREEN (037) - IVORY (138)	04 522
35	Caterpillar mat	L: 28 1/4" - W: 19" - th: 4 3/4".	● ●	IVORY (138)	66 409
36	Small waves	L: 28 1/4" - W: 19" - H: 9 1/2".	● ●	YELLOW (014)	04 520
37	Large waves	L: 28 1/4" - W: 19" - H: 13".	● ●	LIGHT GREEN (037)	04 521
38	Unstable	Side: 19" - H: 2 1/4".	● ●	LIGHT BLUE (057) - IVORY (138)	33 616
39	ROCKER	L: 28 1/4" - W: 19" - H: 9 1/2".	● ●	LIGHT ORANGE (215)	33 617

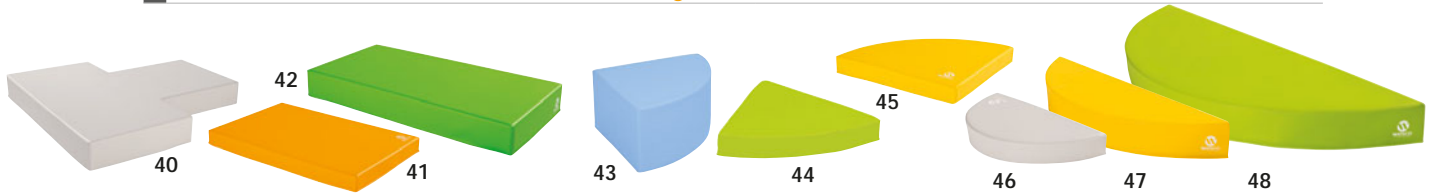

Tiny Tot module Made from 1,5 lbs/ft³ density POLYETHER FOAM covered in a jersey-lined VINYL FABRIC. Fitted with an anti-slip base.

					each
40	T podiums	L: 37 3/4" - W: 37 3/4" - H: 4 3/4".	●	IVORY (138)	59 959
41	Rectangular	L: 28 1/4" - W: 19" - th: 2 1/4".	● ●	LIGHT BLUE (057) - LIGHT ORANGE (215)	04 555
42	Big brick	L: 19" - W: 37 3/4" - H: 4 3/4".	● ● ●	BLUE (214) - GREEN (008) - ORANGE (216)	59 958
43	Quarter circle	H: 31 1/2" to 45 3/4" - Side: 19".	● ●	LIGHT BLUE (057)	53 233
44	60° corner mat	Radius: 19" - th: 2 1/4".	● ●	LIGHT GREEN (037)	04 545
45	90° corner mat	Radius: 19" - th: 2 1/4".	● ●	LIGHT BLUE (057) - YELLOW (014)	04 517
46	Semi-circle mat	L: 19" - W: 9 1/2" - th: 2 1/4".	● ●	IVORY (138)	04 554
47	Small arc	L: 37 3/4" - W: 10 1/2" - th: 4 3/4".	● ●	YELLOW (014)	04 558
48	Large arc	L: 56 3/4" - W: 19" - th: 4 3/4".	● ●	LIGHT GREEN (037)	04 559

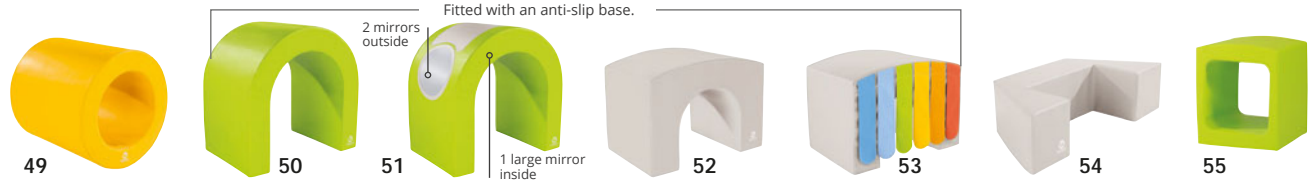

Tiny Tot module Made from 1,5 lbs/ft³ density POLYETHER FOAM covered in a jersey-lined VINYL FABRIC.

					each
49	Barrel	L: 23 1/2" - Ø ext.: 23 1/2" - Ø int.: 15 3/4".	●	YELLOW (014)	00 592
50	Baby arch	L: 30 1/4" - W: 20 1/2" - H: 28 1/4" - Arch 19 x 19" - H. of arch: 23 1/2".	● ● ●	LIGHT BLUE (057) - LIGHT GREEN (037) - IVORY (138)	33 610
51	Baby arch with mirrors	L: 28 1/4" - W: 19" - H: 28 1/4" - Arch: 19 x 19" - H. of arch: 23 1/2".	● ● ●	LIGHT GREEN / IVORY (187)	33 611
52	Tiny Tot bridge	L: 28 1/4" - W: 19" - H: 21 1/4". Arch: L: 40 - W: 19" - H of arch: 15 3/4".	● ●	IVORY (138)	04 012
53	Baby Bridge with Curtain	L: 28 1/4" - W: 19" - H: 21 1/4". Arch: L: 40 - W: 19" - H of arch: 15 3/4".	● ●	IVORY (138)	33 613
54	Half Hexagonal Shape	L: 37 3/4" - W: 19" - th: 9 1/2". Hole: L: 19" - W: 9 1/2".	● ●	IVORY (138)	04 509
55	CLIMB FOAM TUNNEL	L: 20 1/2" - W: 19 3/4" - H: 23 1/2". Arch: L: 19 3/4" - W: 15 1/2" - H of arch: 16 1/4".	●	LIGHT GREEN (037)	63 014

TINY TOT MODULES range

Vibrant colours



Scan the QR Code or enter the code on our website and view this product in 360° augmented reality in your room!

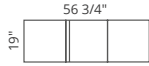
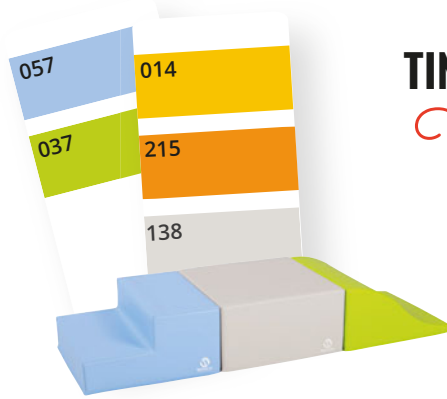

TINY TOT Module The Passage Consists of: 1 half-cube, 1 two-step and 1 soft wave. Ground space: L: 56 3/4" - W: 19". washable with water. Indoor use. Fitted with an anti-slip base.

61 291 set

1 to 3 years
for use under adult supervision

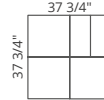

TINY TOT Module Up and Down KIT Consists of: 1 two-step, 1 trapezium, 1 quarter cube and 1 square mat. Ground space: 37 3/4 x 37 3/4". washable with water. Indoor use. Fitted with an anti-slip base.

61 292 set



TINY TOT Module TINY TOT MODULE Rollers KIT Consists of: 2 cylinders Ø 9 1/2", 1 small waves and 1 large waves. Ground space: L: 56 3/4" - W: 19". washable with water. Indoor use. Fitted with an anti-slip base.

61 295 set

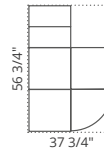
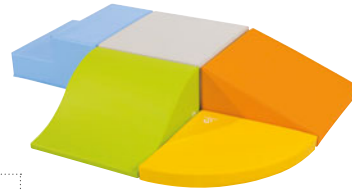

TINY TOT Module Lift KIT Consists of: 1 90° corner mat, 1 half-cube, 1 trapezium, 1 two-step and 1 soft wave. Ground space: L: 56 3/4" - W: 37 3/4". washable with water. Indoor use. Fitted with an anti-slip base.

61 293 set

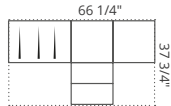
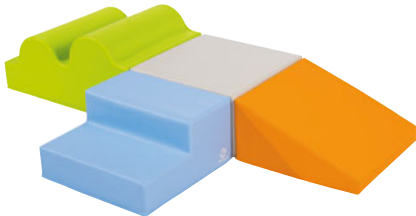

TINY TOT Module Mini Crossing KIT Consists of: 1 large waves, 1 half-cube, 1 trapezium and 1 two-step. Ground space: L: 66 1/4" - W: 37 3/4". washable with water. Indoor use. Fitted with an anti-slip base.

61 296 set

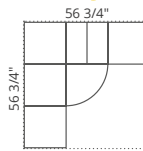
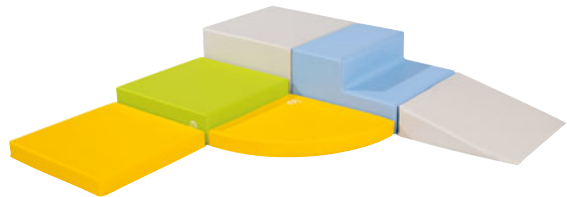

TINY TOT Module TINY TOT MODULE Bend KIT Consists of: 1 half-cube, 1 quarter cube, 1 square mat, 1 90° corner mat, 1 small incline and 1 two-step. Ground space: L: 56 3/4" - W: 56 3/4". washable with water. Indoor use. Fitted with an anti-slip base.

61 297 set

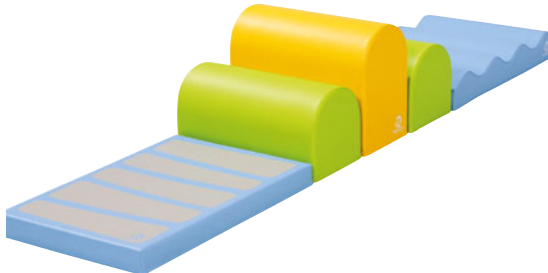

TINY TOT Module The pontoon Consists of: 1 bridge mat, 2 small bumps, 1 large bump and 1 four-wave mat. Ground space: L: 85" - W: 19". washable using a soft cloth in cold soapy water. Indoor use. Fitted with an anti-slip base.

66 431 set

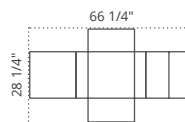

TINY TOT Module Reflection Crawl Away KIT Consists of: 1 two-step, 1 trapezium, 1 rectangular mat and 1 Tiny Tot mirror arch. Ground space: L: 66 1/4" - W: 28 1/4". washable with water. Indoor use. Fitted with an anti-slip base.

61 299 set

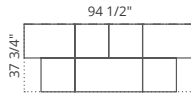

TINY TOT Module Little domino SQUARE MODULES Consists of: 1 T podium, 2 big bricks and 4 high square pouffes, 4 3/4". Ground space: L: 94 1/2" - W: 37 3/4". washable with water. Indoor use. Fitted with an anti-slip base.

61 312 set

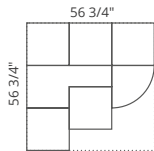
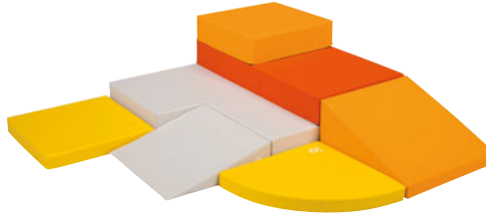

TINY TOT Module TINY TOT MODULE Multiple level KIT Consists of: 1 T podium, 1 half-brick, 1 large brick, 1 square mat H: 2 1/4", 1 trapezium, 1 small slope, 1 square mat H: 4 3/4" and 1 x 90° corner mat. Ground space: L: 56 3/4" - W: 56 3/4". washable with water. Indoor use. Fitted with an anti-slip base.

61 314 set

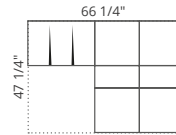
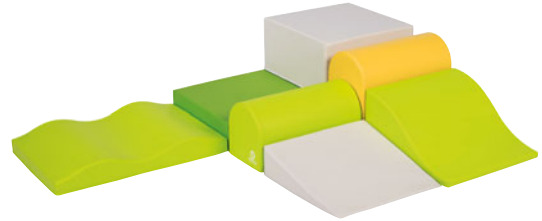

TINY TOT Module Slides KIT Consists of: 1 big brick, 1 half-cube, 1 small incline, 1 soft wave, 1 large bump, 1 small bump and 1 two-wave mat. Ground space: L: 66 1/4" - W: 47 1/4". washable with water. Indoor use. Fitted with an anti-slip base.

61 315 set

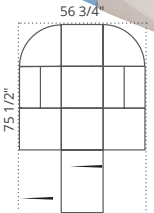
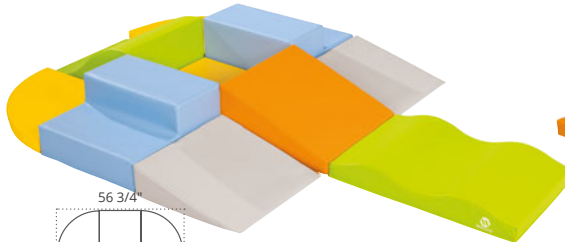

TINY TOT Module Platform KIT Consists of: 2 x 90° corner mats, 2 two-step blocks, 2 small slopes, 1 quarter cube, 1 soft wave, 1 x 2-wave mat and 1 trapezium. Ground space: L: 85" - W: 56 3/4". washable with water. Indoor use. Fitted with an anti-slip base.

61 301 set

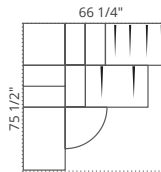

TINY TOT Module Big Corner KIT Consists of: 1 half-cube, 1 two-step, 1 x 4-waves mat, 1 x 2-wave mat, 1 x 90° corner mat, 1 large bump, 2 small bumps and 1 rectangular mat. Ground space: L: 75 1/2" - W: 66 1/4". washable with water. Indoor use. Fitted with an anti-slip base.

61 300 set

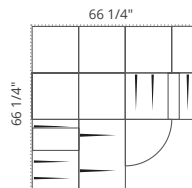

TINY TOT Module TINY TOT Module The Grand Kit Consists of: 1 hill, 1 valley, 1 set of small waves, 2 Ø 9 1/2" cylinders, 1 soft wave, 1 x 4-wave mat, 1 x 2-wave mat, 1 x 90° corner mat, 1 Ø 4 3/4" cylinder and 2 half-moons. Ground space: L: 66 1/4" - W: 66 1/4". washable with water. Indoor use. Fitted with an anti-slip base.

62 152 set

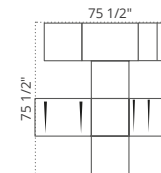

TINY TOT Module TINY TOT MODULE Sensory Pathway KIT Consists of: 1 trapezium, 1 two-step, 1 Tiny Tot bridge with curtain, 2 wobblers, 1 four-wave mat, 1 two-wave mat and 1 square mat. Ground space: L: 75 1/2" - W: 75 1/2". washable with water. Indoor use. Fitted with an anti-slip base.

61 303 set

TINY TOT MODULES range

1 to 3 years
for use under adult supervision
Indoor use.
Fitted with an anti-slip base.

*natural
or bio-based
colours*

Simplicity is the key to awakening. This version in natural colours (light blue, beige, green) allows the child to awaken in a reassuring space, increasing their confidence as they learn motor skills and balance.



TINY TOT MODULE Nature KIT Lift

Consists of: 1 90° corner mat, 1 half-cube, 1 trapezium, 1 two-step and 1 soft wave.

61 309 set

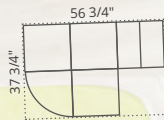

Nature colors

- 057
- 139
- 104
- 037
- 138
- 180

Fabric color biosourced

- 008
- 016
- 020

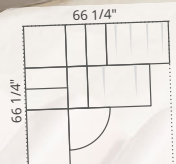

TINY TOT MODULE Nature KIT Big Corner

Consists of: 1 half-cube, 1 two-step, 1 four-waves mat, 1 two-waves mat, 1 90° corner mat, 1 large bump, 2 small bumps and 1 single mat.

61 311 set

- Small bump**
L: 19" - W: 9 1/2" - H: 9 1/2"
- Large bump**
L: 19" - W: 9 1/2" - H: 14 1/4"
- Half-cube**
Side: 19" - H: 9 1/2"
- Trapezium**
Side: 19" - H: 9 1/2"
- Soft wave**
Side: 19" - H: 9 1/2"
- Two steps**
Side: 19" - th: 9 1/2", Step: D: 9 1/2"

BIO-BASED NATURAL TINY TOT MODULE RANGE COTTON-lined vinyl fabric
Colours GREEN (008) NATURAL (016)

- 60 096 each
- 60 089 each
- 60 091 each
- 60 092 each
- 60 093 each

NATURAL TINY TOT MODULE RANGE JERSEY-lined vinyl fabric
Choice of colours: LIGHT BLUE (057) - MOSS GREEN (139) - SPRING GREEN (104) - LIGHT GREEN (037) - IVORY (138) - LIGHT GREY (180)

- 04 552 each
- 04 551 each
- 04 504 each
- 04 514 each
- 04 519 each
- 04 515 each



Fabric made with more than 70% natural cotton, resulting in bio-sourced and Oeko-tex labels









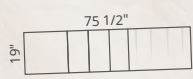

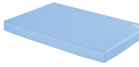





Aqueous coated finish (solvent free), woven appearance and textured feel to prevent the material from becoming distorted

100% made in Canada in short supply chains.

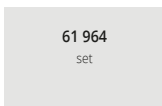
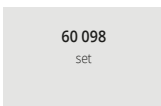

Bio-sourced TINY TOT MODULE
Little Obstacle Course KIT
 Consists of: 1 wobbly, 1 four-waves mat, 1 large bump and 2 small bumps.
 60 099 set

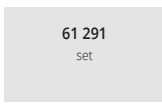
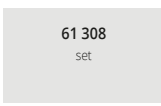

							
Rectangular L: 28 1/4" - W: 19" - th: 2 1/4".	Four waves L: 28 1/4" - W: 19" - th: 4".	2 waves mat L: 28 1/4" - W: 19" - th: 4".	Large waves L: 28 1/4" - W: 19" - H: 13".	90° corner mat Radius: 19" - th: 2 1/4".	Unstable Side: 19" - H: 2 1/4".	The Passage Ground space: L: 56 3/4" - W: 19".	Mini Crossing KIT Ground space: L: 66 1/4" - W: 37 3/4".
	 60 094 each		 60 095 each		 60 097 each	 61 964 set	 60 098 set
 04 555 each	 04 523 each	 04 522 each	 04 521 each	 04 517 each	 61 291 set	 61 308 set	

wesco
design

2-YEAR GUARANTEE
except cover

MADE IN CANADA

Complies with standard
NFS 54-300:
motor activity safety.

Phthalate-free.
Free of azo dyes.

SENSORY TINY TOT range

1 to 3 years
for use under adult
supervision

2-in-1: motor and sensory courses!

In addition to our Tiny Tot modules, the Sensory Tiny Tot items offer a sensory, visual and tactile experience in the discovery of different materials.

INCLUSIVE solutions

Tactile products sharpen sensations for sight-impaired children or those with reduced feeling in their fingers.

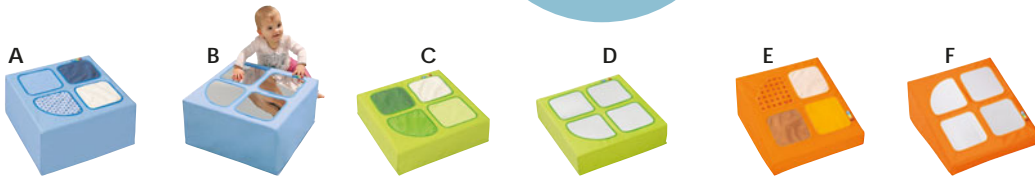

SENSORY Tiny Tot modules Consists of: 1 half-cube and 1 cover. Made from 1,5 lbs/ft³ density POLYETHER FOAM covered in a jersey-lined VINYL FABRIC and VARIED FABRIC. Washable at 86 °F (removable cover). Indoor use.

				SENSORY REPLACEMENT COVER		
A	Multi-textured half-cube	Side: 19" - H: 9 1/2".	65 375	set	46 622	each
B	Mirrored half-cube	Side: 19" - H: 9 1/2".	65 376	set	46 625	each
C	Multi-textured quarter cube	Side: 19" - H: 4 3/4".	65 377	set	46 621	each
D	Quarter cube Mirror	Side: 19" - H: 4 3/4".	65 378	set	46 624	each
E	Multi-textured trapezium	Side: 19" - H. max: 9 1/2".	65 379	set	46 623	each
F	Mirror trapezium	Side: 19" - H. max: 9 1/2".	65 381	set	46 626	each



SENSORY Tiles By walking barefoot on the sensory tiles or touching them with their little hands, children discover new sensations of varying intensity depending on the textures. Consists of: 1 foam tile and 1 removable cover. Side: 19" - th: 1/2". Made from VARIED FABRIC and VINYL FABRIC. Washable at 86 °F (removable cover). Indoor use. Fitted with an anti-slip base. Colours LIGHT GREEN (037)

				SENSORY REPLACEMENT COVER		
G	Silky		63 098	set	62 474	each
H	Soft		63 121	set	62 475	each
I	Graphic		63 122	set	62 476	each
J	Shiny		63 123	set	62 477	each
K	Surface non-slip		63 124	set	62 478	each
L	Smooth		63 125	set	62 479	each

Tile SENSORY MAXI PACK	6 foam tiles and 6 removable covers.	62 487	set
-------------------------------	--------------------------------------	---------------	-----

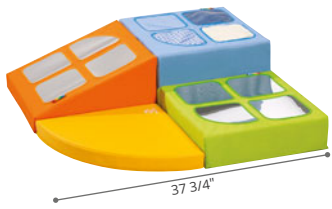

TINY TOT MODULE Sensory Discovery KIT
 Consists of: 1 mirrored quarter cube, 1 multi-textured half-cube, 1 mirrored trapezium, 1 90° corner mat.
 Floor space : L: 37 3/4" - W: 37 3/4". Indoor use.

65 382 set



TINY TOT MODULE Sensory Landing KIT
 Consists of: 1 mirrored quarter cube, 1 multi-textured quarter cube, 1 multi-textured semi-cube, 1 mirrored trapezium and 2 square mats. Ground space:
 L: 56 3/4" - W: 37 3/4". Indoor use.

65 383 set

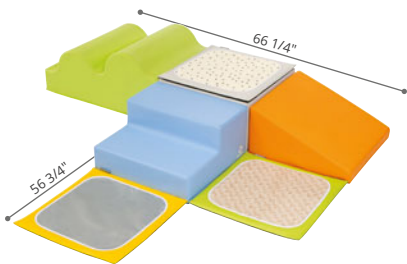

Sensory Awakening Tiny Tot module kit
 Consists of: 1 large wave, 1 half-cube, 1 trapezium, 1 two step and 3 sensory tiles. Ground space:
 L: 66 1/4" - W: 56 3/4". Indoor use. Fitted with an anti-slip base.

65 292 set

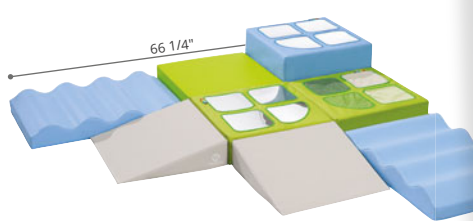

TINY TOT MODULE Sensory Pathway KIT
 Consists of: 1 mirrored quarter cube, 1 multi-textured quarter cube, 1 quarter cube, 1 mirrored semi-cube, 2 small slopes, 2 mats with 4 waves. Ground space:
 L: 66 1/4" - W: 66 1/4". Indoor use.

65 384 set



From birth
4 DENSITY TILES The different densities of the 4 density tiles are a chance to adapt and readjust motor skills. Used in many ways (loose, organised in a flat or upward course), they create a multitude of educational exercises based around the development of recognition and fine motor skills. Each density is defined by a specific colour. Consists of: 1 very soft blue block (65 N), 1 soft yellow block (110 N), 1 firm light orange block (190 N) and 1 very firm light green block (300 N). L: 19" - W: 9 1/2" - th: 2 1/4". Made from VINYL COVERS. washable with water. Indoor use.

62 855 pack of 4

In 1984, Wesco was the first designer and manufacturer to offer a range of foam motor skills modules. Designed in collaboration with occupational therapists, this range encourages the expression of childhood characteristics: spontaneity, naturalness, the need to experiment, to move... Used singly or in a number of different combinations, BLOCmodules offer a multitude of possibilities, allowing children to master their motor skills using their whole body, develop their movements, take risks and sequence motor skills actions, etc.



**Christelle,
Designer at Wesco**

While crawling, stepping over, balancing and developing a sense of security and self-confidence, children over the age of 3 learn to master their motor skills and acquire initiative and perseverance using these modules that are designed, developed and made in France!

PLEASE NOTE: this motor skills equipment should be used for supervised educational activities, independently or under the guidance of qualified professionals



wesco
design

2 YEAR GUARANTEE

MADE IN CANADA

Complies with standard
EN 1021-1 and 2:
flammability of filled
furnishings

Complies with standard
NFS 54-300 :
motor activity safety

Phthalate-free.

+3 years
for use under adult
supervision

BLOC MODULE Range

The first motor skill modules for children aged 3+!

Very resistant vinyl fabric, easy to clean.
1,5 lbs/ft³ foam: long-lasting and durable,
will not lose its shape.



Firm, comfortable foam: 1,5 lbs/ft³
density polyether foam for greater
longevity over time: does not sag.

Ultra resistant seams: All our
modules are sewn, with no zip
fastenings, to avoid injuring children.
Our "embroidered" stitching seals
the modules, and prevents children
from getting inside them.

Highly resistant fabric: Vinyl fabric
on a jersey support, stitched all
round with extra strong nylon thread.
This covering does not lead to friction
burns in children.

Hygienic: the vinyl fabric is easy to
clean with a soft cloth or sponge and
cold, soapy water.



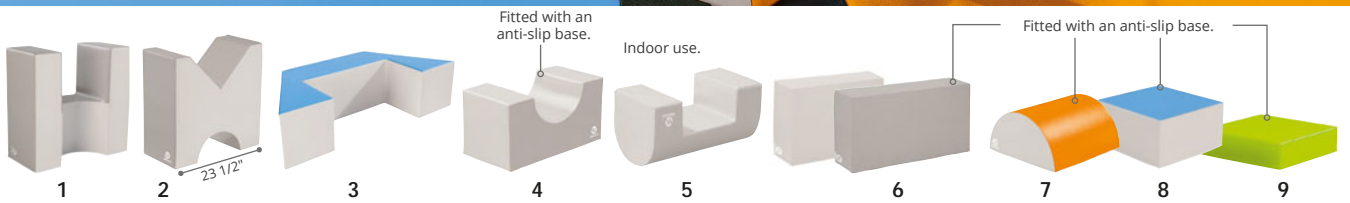

BLOCMODULES Made from 1,5 lbs/ft3 density POLYETHER FOAM covered in a jersey-lined VINYL FABRIC. Washable with water.
Indoor use.

			each
1	U-shaped dual purpose frame	L: 23 1/2" - W: 11 3/4" - H: 23 1/2".	● LIGHT GREY / IVORY (181) 00 187
2	Angled frame	L: 23 1/2" - W: 11 3/4" - H: 23 1/2".	● LIGHT GREY / IVORY (181) 00 102
3	Half Hexagonal Shape	L: 47 1/4" - W: 20 1/2" - H: 11 3/4". Hole: L: 23 1/2" - W: 11 3/4" - H: 11 3/4".	● BLUE/IVORY (224) 00 161
4	Rectangular bridge	L: 23 1/2" - W: 11 3/4" - H: 11 3/4".	● LIGHT GREY / IVORY (181) 00 263
5	Half-oval bridge	L: 23 1/2" - W: 11 3/4" - H: 11 3/4" - Int. : 11 3/4" - Inside 11 3/4 x 6".	● LIGHT GREY / IVORY (181) 00 148
6	Obstacle wall L: 47 1/4".	L: 35 1/2" - W: 23 1/2" - th: 11 3/4".	● IVORY (138) 00 139
7	Obstacle wall L: 47 1/4".	L: 47 1/4" - W: 23 1/2" - th: 11 3/4".	● LIGHT GREY (180) 00 137
8	Half moon	L: 23 1/2" - H: 11 3/4" - Ø 23 1/2".	● LIGHT ORANGE/IVORY (222) 00 129
9	Half-cube	Side: 23 1/2" - H: 11 3/4".	● BLUE/IVORY (224) 00 130
	Quarter Cube	Side: 23 1/2" - H: 6".	● LIGHT GREEN (037) 00 979

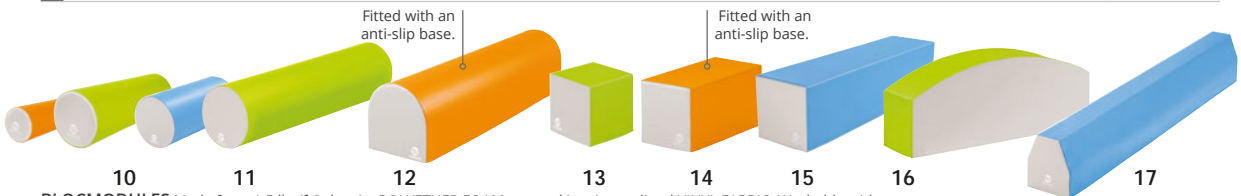

BLOCMODULES Made from 1,5 lbs/ft3 density POLYETHER FOAM covered in a jersey-lined VINYL FABRIC. Washable with water.
Indoor use.

			each
10	Small cylinder	L: 23 1/2" - Ø 6".	● LIGHT ORANGE/IVORY (222) 00 977
	Medium cylinder	L: 23 1/2" - Ø 7 3/4".	● LIGHT GREEN / IVORY (187) 00 120
	Large cylinder	L: 23 1/2" - Ø 11 3/4".	● BLUE/IVORY (224) 00 125
11	Maxi cylinder	L: 47 1/4" - Ø 11 3/4".	● LIGHT GREEN / IVORY (187) 00 141
12	Beam	L: 47 1/4" - W: 11 3/4" - H: 11 3/4".	● LIGHT ORANGE/IVORY (222) 00 151
13	Cube	Side: 11 3/4".	● IVORY (138) - LIGHT GREEN / IVORY (187) 00 131
14	Long Cube	L: 23 1/2" - W: 11 3/4" - H: 11 3/4".	● LIGHT ORANGE/IVORY (222) 00 126
15	Bench/beam	L: 47 1/4" - W: 11 3/4" - H: 11 3/4".	● BLUE/IVORY (224) 00 152
16	Balance beam	L: 47 1/4" - W: 11 3/4" - H: 11 1/2" to 15 3/4".	● LIGHT GREEN / IVORY (187) 00 103
17	Balance beam	L: 78 3/4" - W: 4 3/4" to 9 3/4" - H: 11 3/4".	● BLUE/IVORY (224) 23 692



wesco
design

2 YEAR GUARANTEE

MADE IN CANADA

Complies with standard EN 1021-1 and 2: flammability of filled furnishings

Complies with standard NFS 54-300: motor activity safety

Phthalate-free.

+ 3 years
for use under adult supervision

BLOC MODULE Range



BLOCMODULES Made from 1,5 lbs/ft3 density POLYETHER FOAM covered in a jersey-lined VINYL FABRIC. Washable with water. Indoor use.

				each
18	Low cylinder	L: 11 3/4" - Ø 23 1/2".	● LIGHT GREEN / IVORY (187)	53 232
18	Medium cylinder	L: 23 1/2" - Ø 23 1/2".	● LIGHT ORANGE/IVORY (222)	00 127
	Large cylinder	L: 31 1/2" - Ø 23 1/2".	● BLUE/IVORY (224)	23 677
19	Large wheel	Ø 47 1/4" - th: 11 3/4" - Ø int.: 23 1/2".	● LIGHT GREEN/LIGHT GREY (206)	00 138
20	Barrel	L: 23 1/2" - Ø ext.: 23 1/2" - Ø int.: 15 3/4".	● YELLOW (014) - BLUE/IVORY (224)	00 592
21	Tyre	Ø 23 1/2" - th: 11 3/4" - Ø int.: 11 3/4".	● LIGHT GREY (180)	00 180
22	Babytunnel	W: 23 1/2" - H: 15 3/4" - th: 4" - D: 11 3/4". L. of tunnel: 15 3/4".	● LIGHT ORANGE/IVORY (222)	00 593
23	Tunnel	L: 31 1/2" - W: 23 1/2" - H: 23 1/2". L. of tunnel: 15 3/4".	● LIGHT GREEN / IVORY (187)	00 133
24	Semi-circle	Ø 47 1/4" - th: 11 3/4" - Ø int.: 23 1/2".	● BLUE (214)	00 144

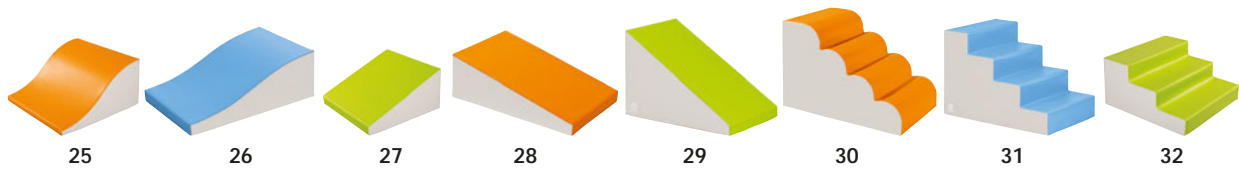

BLOCMODULES Made from 1,5 lbs/ft3 density POLYETHER FOAM covered in a jersey-lined VINYL FABRIC. Washable with water. Indoor use. Fitted with an anti-slip base.

				each
25	Strong Wave	Side: 23 1/2" - H: 7 to 11 3/4".	● LIGHT ORANGE/IVORY (222)	00 157
26	Soft wave	L: 35 1/2" - W: 23 1/2" - H: 7 to 11 3/4".	● BLUE/IVORY (224)	00 990
27	Trapezium	Side: 23 1/2" - H: 7 to 11 3/4".	● LIGHT GREEN / IVORY (187)	00 124
28	Large ramp	L: 35 1/2" - W: 23 1/2" - H: 7 to 11 3/4".	● LIGHT ORANGE/IVORY (222)	00 989
29	Maxi incline	L: 35 1/2" - W: 23 1/2" - H: 7 to 23 1/2".	● LIGHT GREEN / IVORY (187)	00 101
30	Maxi bump	L: 35 1/2" - W: 23 1/2" - H: 23 1/2".	● LIGHT ORANGE/IVORY (222)	00 158
31	Four steps for Cosy Giant Ball Pool	L: 35 1/2" - W: 23 1/2" - H: 23 1/2". Step: H: 6" - D: 8 3/4".	● BLUE/IVORY (224)	01 317
32	Three Step	Side: 23 1/2" - max H: 11 3/4". Step: D: 7 3/4".	● LIGHT GREEN / IVORY (187)	00 982

BLOC MODULE Range

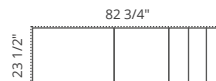

A BLOCMODULE KIT Platform Consists of: 1 half-cube, 1 three-step and 1 soft wave. Ground space: L: 82 3/4" - W: 23 1/2". Made from Stitched jersey-lined 1,5 lbs/ft³ density VINYL FABRIC, washable using a soft cloth in cold soapy water. Indoor use. Supplied with an educational booklet.

61 276 set

A

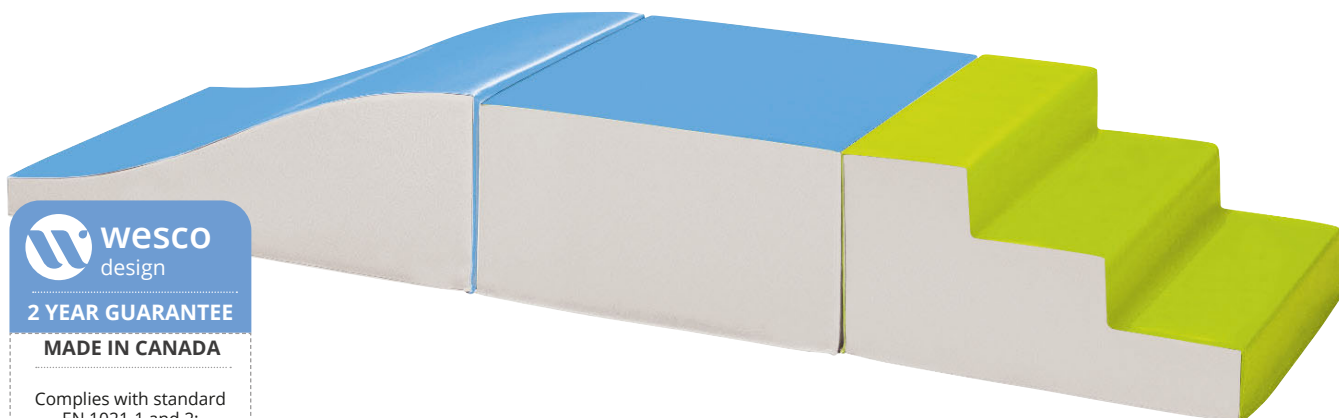

2 YEAR GUARANTEE

MADE IN CANADA

Complies with standard EN 1021-1 and 2: flammability of filled furnishings

Complies with standard NFS 54-300: motor activity safety

Phthalate-free.

Supplied with an educational booklet.



+ 3 years for use under adult supervision

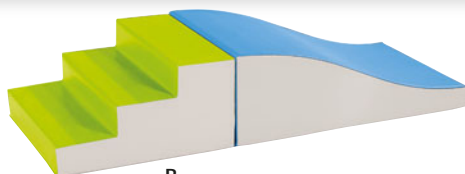

B

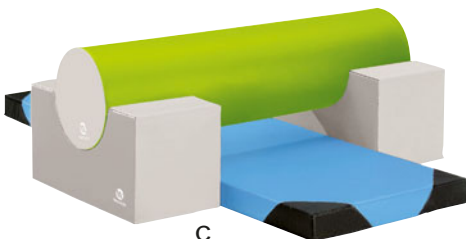

C

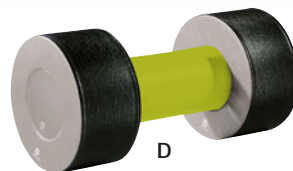

D

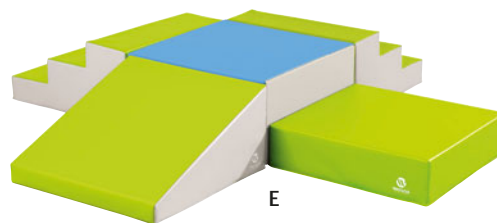

E

B BLOCMODULE KIT Stair-slope Consists of: 1 three-step and 1 soft wave. Ground space: L: 59" - W: 23 1/2". Made from Stitched jersey-lined 1,5 lbs/ft³ density VINYL FABRIC, washable using a soft cloth in cold soapy water. Indoor use. Supplied with an educational booklet.

61 277 set

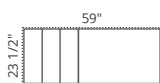

D BLOCMODULE KIT Roll Consists of: 1 maxi cylinder and 2 tyres. Ground space: L: 47 1/4" - W: 23 1/2". Made from Stitched jersey-lined 1,5 lbs/ft³ density VINYL FABRIC, washable using a soft cloth in cold soapy water. Indoor use. Supplied with an educational booklet.

61 279 set

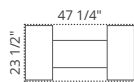

C BLOCMODULE KIT Balance Consists of: 1 maxi cylinder, 1 landing mat L: 70 3/4" - W: 23 1/2" and 2 rectangular bridges. Ground space: L: 70 3/4" - W: 47 1/4". Made from Stitched jersey-lined 1,5 lbs/ft³ density VINYL FABRIC, washable using a soft cloth in cold soapy water. Indoor use. Supplied with an educational booklet.

61 278 set

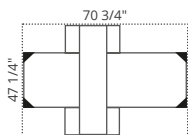

E BLOCMODULE KIT Landing Consists of: 2 three-step blocks, 1 half-cube, 1 trapezium and 1 quarter cube. Ground space: L: 70 3/4" - W: 70 3/4". Made from Stitched jersey-lined 1,5 lbs/ft³ density VINYL FABRIC, washable using a soft cloth in cold soapy water. Indoor use. Supplied with an educational booklet.

61 280 set

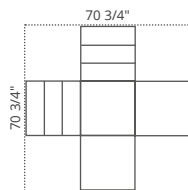

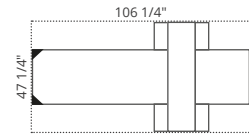

F BLOCMODULE KIT Arch Consists of: 1 trapezium, 1 semi-circle, 1 landing mat and 2 U-shaped fittings. Ground space: L: 106 1/4" - W: 47 1/4". Made from VINYL COVERS, washable using a soft cloth in cold soapy water. Indoor use. Supplied with an educational booklet.

61 281

set



G

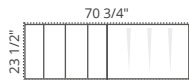

G BLOCMODULE KIT Ascent Consists of: 1 four-step and 1 maxi bumps. Ground space: L: 70 3/4" - W: 23 1/2". Made from Stitched jersey-lined 1,5 lbs/ft3 density VINYL FABRIC. washable using a soft cloth in cold soapy water. Indoor use. Supplied with an educational booklet.

61 282

set



H

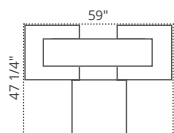

H BLOCMODULE KIT Ring Consists of: 1 trapezium, 1 large wheel and 2 U-shaped fittings. Ground space: L: 59" - W: 47 1/4". Made from Stitched jersey-lined 1,5 lbs/ft3 density VINYL FABRIC. washable using a soft cloth in cold soapy water. Indoor use. Supplied with an educational booklet.

61 283

set

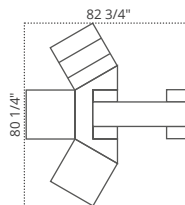

I BLOCMODULE KIT 3 entries Consists of: 2 U-shaped fittings, 1 bench/beam, 1 three-step, 1 strong wave, 1 trapezium and 1 half-hexagon. Ground space: L: 82 3/4" - W: 80 1/4". Made from Stitched jersey-lined 1,5 lbs/ft3 density VINYL FABRIC. washable using a soft cloth in cold soapy water. Indoor use. Supplied with an educational booklet.

61 284

set

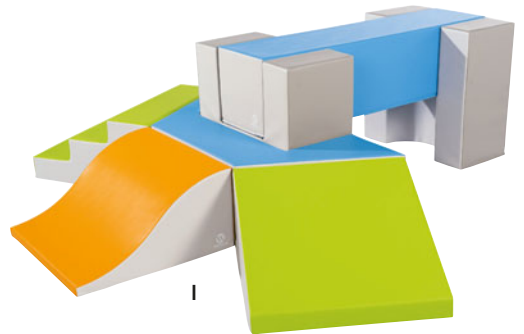

I

Complies with standard EN 1021-1 and 2: flammability of filled furnishings

Complies with standard NFS 54-300: motor activity safety

Phthalate-free.

Supplied with an educational booklet.



+ 3 years
for use under adult supervision

BLOC MODULE

Range

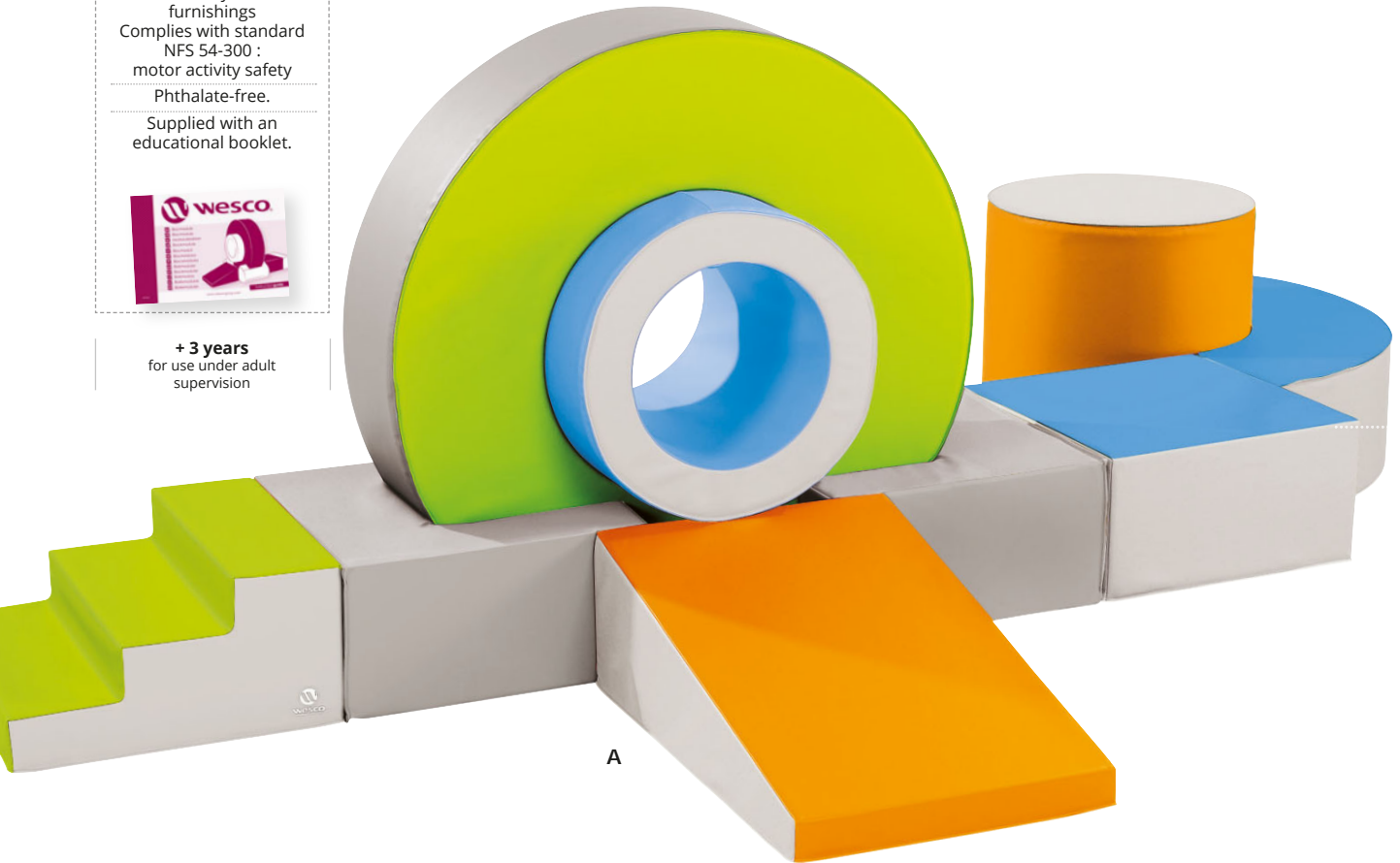

A

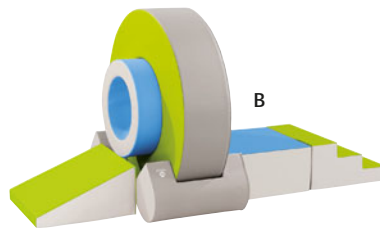

B

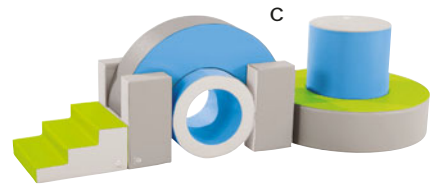

C

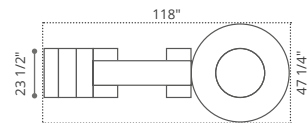
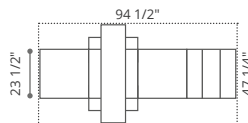
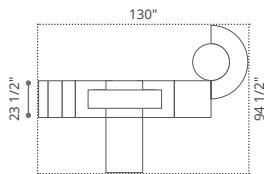

A BLOCMODULE KIT Serpentine Consists of: 1 large wheel, 1 barrel, 1 three step, 2 U-shaped connectors, 1 large slope, 1 semi-cube, 1 medium cylinder and 1 semi-circle Ground space: L: 130" - W: 94 1/2". Made from Stitched jersey-lined 1,5 lbs/ft3 density VINYL FABRIC. washable using a soft cloth in cold soapy water. Indoor use. Supplied with an educational booklet.

61 285

set

B BLOCMODULE KIT Above Below Consists of: 1 large wheel, 1 barrel, 2 semi-oval bridges, 1 trapezium, 1 semi-cube and 1 three step. Ground space: L: 94 1/2" - W: 47 1/4". Made from Stitched jersey-lined 1,5 lbs/ft3 density VINYL FABRIC. washable using a soft cloth in cold soapy water. Indoor use. Supplied with an educational booklet.

61 286

set

C BLOCMODULE KIT Tunnel Consists of: 1 high cylinder, 1 large wheel, 2 U-shaped blocks, 1 barrel, 1 semi-cube and 1 three step. Ground space: L: 118" - W: 47 1/4". Made from Stitched jersey-lined 1,5 lbs/ft3 density VINYL FABRIC. washable using a soft cloth in cold soapy water. Indoor use. Supplied with an educational booklet.

61 287

set

CLIMB UP range – Climbing walls

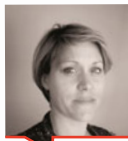

Emmanuelle Langlois,
Psychomotor Therapist.

By climbing, children learn to steady themselves, find their balance and develop hand-eye coordination. It also allows them to conquer their fears and take measured risks, enabling them to trust their body and better control it in any situation.

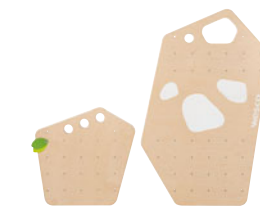

2 CLIMB Up Panels KIT Consists of: 1 large panel and 1 small panel. Large panel: W: 30 1/4" - H: 46 1/2". Small panel: W: 24" - H: 23 1/2" - th: 3/4". Made from varnished PLYWOOD. Delivered flat-packed, do-it-yourself installation. Supplied without wall fixings.

58 553 set



Set of 2 CLIMB Up cross pieces
L: 21 3/4" - W: 4 3/4" - th: 3/4". Made from Lacquered WOOD. Delivered flat-packed, do-it-yourself installation.

58 555 pack of 2



Set of 4 CLIMB Up holds L: 7" - W: 1/4". Made from CORK.

58 563 pack of 4



Set of 2 CLIMB Up rope grips
Made from PLASTIC. Self-assembly.

65 006 pack of 2

Safe area:
without climbing elements for children under 3 years.

CLIMB Up The great ascent Consists of: 6 CLIMB Up panels, 4 cross pieces, 8 holds, 1 set of scarves, 1 rope hold, 4 rope grips, 2 Tiny Tot wall mats and 4 Mosaic mats. With mat: L: 151 1/4". Made from WOOD. Delivered flat-packed, do-it-yourself installation. Supplied without wall fixings.

58 576 set



CLIMB Up Little climbers Consists of: 2 CLIMB Up panels, 2 cross pieces, 4 holds and 2 Mosaic mats. With mat: L: 75 1/2". Made from WOOD. Delivered flat-packed, do-it-yourself installation. Supplied without wall fixings.

58 565 set

CLIMB Up Great adventurers Consists of: 4 CLIMB Up panels, 4 cross pieces, 4 holds, 1 set of scarves, 1 rope hold, 2 rope grips, 1 Tiny Tot wall mat and 3 Mosaic mats. With mat: L: 113 1/2". Made from WOOD. Delivered flat-packed, do-it-yourself installation. Supplied without wall fixings.

58 574 set



NUMBERED JUGGLING BALLS WITH SCARVES ASSORTMENT of 6 colours. Ball: Ø 2 1/4". Scarf: 11 3/4". Made from FABRIC.

51 208 pack of 6

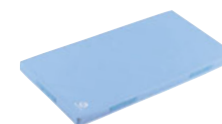

From birth
Mosaic mats 37 3/4 x 19"
Thickness: 1 1/2".

26 781 each

This equipment for developing motor skills is used for supervised educational activities, free expression or under the guidance of qualified professionals.

 **wesco**
design

3 YEAR GUARANTEE

MADE IN EUROPE

Complies with standard
NFS 54-300 : motor activity
safety

Phthalate-free.



BABIXPLORE Range

+ 12 months
for use under adult
supervision

Create versatile,
highly-robust courses.

+ **Sturdy and safe:** These very strong plastic modules can support a child's weight. No sharp edges. For indoor/outdoor use. The components are manufactured with support walls to ensure child safety.

Simple assembly: The modules link firmly together without the need for additional fixings. Upper surface is textured and non-slip.

Hygiene: Easy to clean.



BABIXPLORE STAIRS L: 28 1/4" -
W: 26 1/2" - H: 28 1/4". Made from
thick POLYETHYLENE, washable with
water. For indoor and outdoor use.
Choice of colours: BLUE (002) -
GREEN (008)

12 648 each

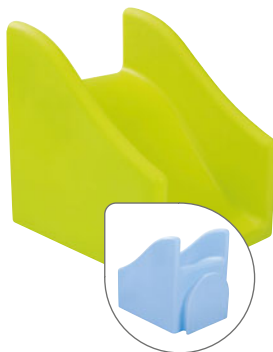

BABIXPLORE SLIDE L: 31 1/4" -
W: 26 1/2" - H: 28 1/4". Made from
thick POLYETHYLENE, washable with
water. For indoor and outdoor use.
Choice of colours: LIGHT BLUE
(057) - LIGHT GREEN (037)

12 649 each





BABIXPLORE WALKWAY L: 26 1/2" -
W: 26 1/2" - H: 34". Small walkway:
H: 14 3/4". Large walkway: H: 18".
Made from thick POLYETHYLENE,
washable with water. For indoor and
outdoor use. Choice of colours: LIGHT
BLUE (057) - LIGHT GREEN (037)

20 003 each

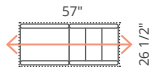

BABIXPLORE PLATFORM Side:
26 1/2" - H: 19". Made from thick
POLYETHYLENE, washable with water.
For indoor and outdoor use. Colours
GREY (006)

58 116 each



BABIxplore Passageway KIT
 Consists of: 1 staircase and 1 slide.
 Floor space : L: 57" - W: 26 1/2".
 Made from thick POLYETHYLENE. washable with water. For indoor and outdoor use. Choice of colours: GREEN/LIGHT GREEN (169) - BLUE/LIGHT BLUE (059)

39 807 set

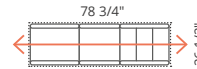

BABIxplore The viaduct KIT
 Consists of: 1 staircase, 1 walkway and 1 slide. Floor space : L: 78 3/4" - W: 26 1/2".
 Made from thick POLYETHYLENE. washable with water. For indoor and outdoor use. Choice of colours: GREEN/LIGHT GREEN (169) - BLUE/LIGHT BLUE (059)

39 809 set

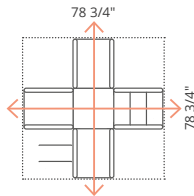
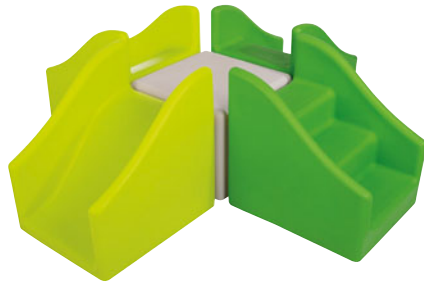

BABIxplore Crossroads KIT
 Consists of: 2 stairs, 1 grey platform and 2 slides. L: 78 3/4" - W: 78 3/4".
 Made from thick POLYETHYLENE. washable with water. For indoor and outdoor use. Choice of colours: GREEN/LIGHT GREEN (169) - BLUE/LIGHT BLUE (059)

58 163 set

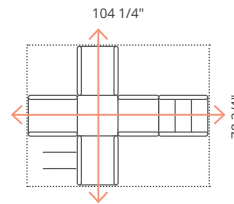
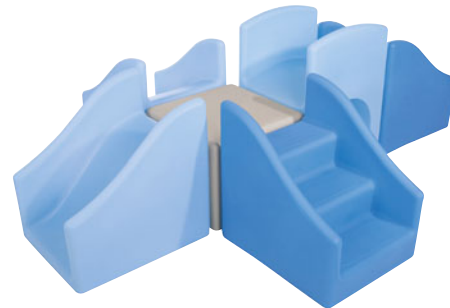

BABIxplore Large Crossroads KIT
 Consists of: 2 stairs, 1 grey platform, 1 walkway and 2 slides. L: 104 1/4" - W: 78 3/4".
 Made from thick POLYETHYLENE. washable with water. For indoor and outdoor use. Choice of colours: GREEN/LIGHT GREEN (169) - BLUE/LIGHT BLUE (059)

58 199 set

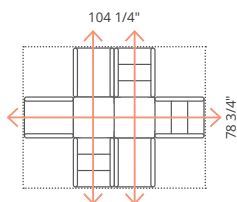

BABIxplore Unbelievable KIT
 Consists of: 3 stairs, 2 grey platforms and 3 slides. L: 104 1/4" - W: 78 3/4".
 Made from thick POLYETHYLENE. washable with water. For indoor and outdoor use. Choice of colours: GREEN/LIGHT GREEN (169) - BLUE/LIGHT BLUE (059)

58 246 set

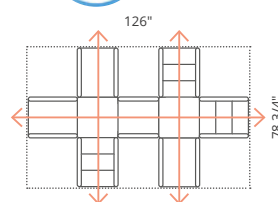

BABIxplore Magnificent KIT
 Consists of: 3 stairs, 2 platforms, 1 walkway, 3 slides and 2 hoops Ø 13 3/4". L: 126" - W: 78 3/4".
 Made from thick POLYETHYLENE. washable with water. For indoor and outdoor use. Choice of colours: GREEN/LIGHT GREEN (169) - BLUE/LIGHT BLUE (059)

59 335 set

Increased safety thanks to our ramps

Use of the 'rock' to create a bidirectional course

These sturdy boards can support the weight of several children, or an adult



wesco
design

3 YEAR GUARANTEE

MADE IN EUROPE

Complies with standard
NFS 54-300 : motor activity
safety

Phthalate-free.

new colours EXPLOR'ACTION range

3 to 6 years
for use under adult
supervision

Diverse motor skills experiences both indoors and outdoors.

Create a range of courses and easily adapt the desired level of difficulty by moving the pieces around on the ground or in the grooves in the "rock" pieces. This versatility allows you to create an infinite range of courses, giving your children a new adventure every day. EXPLOR'ACTION blocks enable children to master their motor skills and acquire confidence, the ability to take the initiative and develop confidence in their physical abilities.



Christelle Boutin,
Designer at Wesco

Designed to be used inside and outside, the components in the EXPLOR'action range offer various possibilities for climbing, crawling, working on balance, etc. Made from recyclable plastic, they combine three unique advantages: they are lightweight, robust and flexible!

Above/below courses with the board/tunnel

Chaotic course (ascending or descending) with the sloped boards

Non-slip, grooved surface

Use of the sloped board (arch) with the housing



100% recyclable.



Safety:

For added safety, the blocks in this range do not have any sharp edges.

Very strong:

The blocks in the EXPLOR'action range support the weight of several children or an adult.

Lightweight:

The blocks can be moved around by children.

Easy to assemble:

The blocks link together easily and firmly without the need for additional connecting parts that could get lost or even be hazardous.

Hygiene:

The blocks are easy to clean and can be disinfected.

Durable:

Manufactured from materials suitable for outdoor use (composite wood, high-density anti-UV treated plastic, aluminium).



EXPLOR'ACTION range



EXPLOR'ACTION KIT
Made from thick POLYETHYLENE.
 Washable with water.
 For indoor and outdoor use.



Supplied with an educational booklet.



The springboard

Ground space: L: 94 1/2" - W: 20 3/4".

Consists of: 1 housing,
 1 straight board
 and 1 sloped board.

67 525

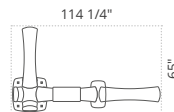

Corner

Ground space: L: 114 1/4" - W: 65".

Consists of: 1 rock, 1 housing,
 1 straight board, 1 tunnel board
 and 1 sloped board.

67 526

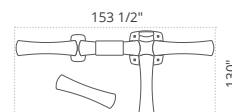

Large crossing

Ground space: L: 153 1/2" - W: 130".

Consists of: 1 rock, 1 housing,
 2 straight boards, 1 tunnel board
 and 2 sloped boards.

67 527

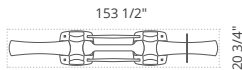

new

Crossing

Ground space: L: 153 1/2" - W: 20 3/4"

Consists of: 2 rocks, 1 sloped board, 1 straight board, 1 beam, 1 set of 2 rails and 1 x Ø 19 3/4" hoop.

67 590

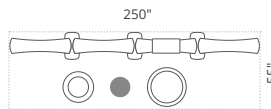

Ramps

Ground space: L: 250" - W: 55"

Consists of: 3 housings, 2 straight boards, 1 tunnel board, 1 sloped board and 1 wheel kit.

67 528

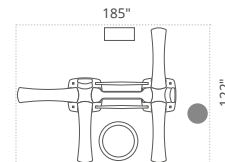

new

Balancing board

Ground space: L: 185" - W: 122"

Consists of: 2 rocks, 2 straight boards, 2 sloped boards, 1 beam, 1 set of 2 rails and 1 set of 3 wheels.

67 898



EXPLOR'ACTION range



EXPLOR'action KIT
Made from thick POLYETHYLENE.
Washable with water.
For indoor and outdoor use.



Supplied with an educational booklet.

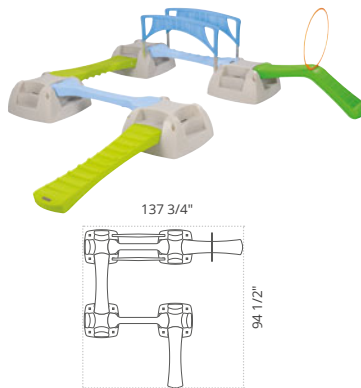

new

Acrobats

Floor space L: 137 3/4" - W: 94 1/2".

67 589

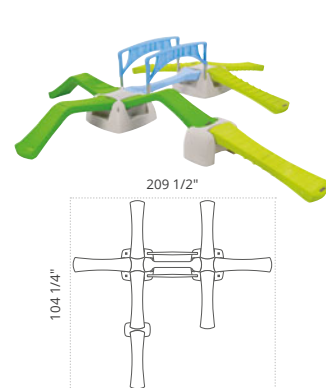

new

The aqueduct

Ground space: L: 209 1/2" - W: 104 1/4".

Consists of: 2 rocks, 1 housing, 4 straight boards, 3 sloped boards, 1 beam and 1 set of 2 rails.

67 530

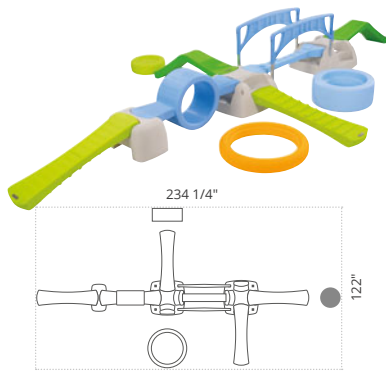

new

Awesome

Ground space: L: 234 1/4" - W: 122".

Consists of: 2 rocks, 1 housing, 2 straight boards, 2 sloped boards, 1 tunnel board, 1 beam, 1 set of 2 rails and 1 set of 3 wheels.

67 531

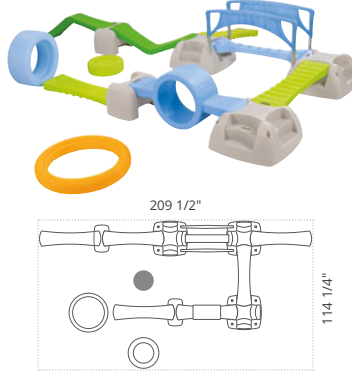

new

Fabulous

Ground space: L: 209 1/2" - W: 114 1/4".

Consists of: 3 rocks, 2 housings, 3 straight boards, 2 sloped boards, 1 tunnel board, 1 beam, 1 set of 2 rails and 1 set of 3 wheels.

67 532

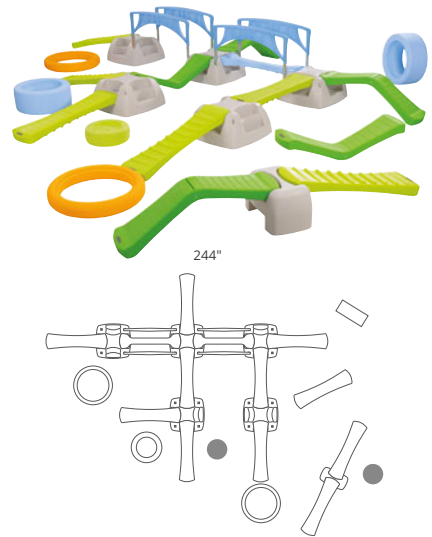

The giant

Ground space: L: 256" - W: 244".

Consists of: 5 rocks, 1 housing, 6 straight boards, 5 sloped boards, 2 beams, 2 sets of 2 rails and 2 sets of 3 wheels.

67 533



wesco
design

3 YEAR GUARANTEE

MADE IN CANADA

Complies with standard
NFS 54-300 :
motor activity safety

Phthalate-free.

3 to 6 years
for use under adult supervision

All of our products need to be
used under adult supervision.

Strength

Modularity

Designed for use indoors or outdoors, the "Alfresco" blocks are easy to assemble and changed at will. They will allow children to develop their motor skills, which will improved self confidence, encourage initiative and help them beleive in themselves.

Durable: Rotomolded in Canada from high density and high strength plastic.



Safety

For added safety, the blocks in this range have no sharp edges.

Very strong

The blocks in the Alfresco range are sturdy and will support the weight of several children or an adult.

Light

The blocks are light and can be moved by children.

Hygienic

Blocks are easy to clean and can be disinfected.

Easy to assemble

The blocks link together easily without the need for additional connecting parts.



100%
recyclable.



Anti-slip grooved surface



ALFRESCO SLOT-IN TUNNEL This attractive component is extremely versatile. On its own it forms a simple tunnel which children can pass over or through. When used with beams, it becomes a bridge that children can cross in several ways: flat, on stairs or slopes. L: 31 1/2" - l: 23 1/2" - H: 23 1/2". Made from thick POLYETHYLENE.

12 251 each

One side for a horizontal beam, the other for a slope



ALFRESCO H SHAPED SLOT-IN BLOCK This block is reversible and can be used to hold beams in a horizontally or a sloping position. L: 23 1/2" - W: 11 3/4" - H: 17 3/4". Made from thick POLYETHYLENE.

04 711 each



Three-directional on one side:
Helps to create a sloping pathways

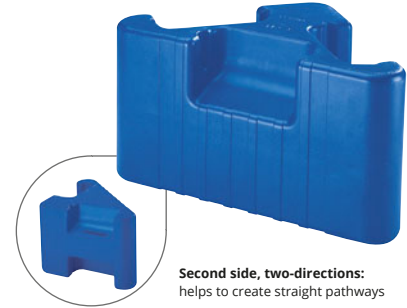

Second side, two-directions:
helps to create straight pathways

ALFRESCO Y-SHAPED SLOT-IN BLOCK This versatile fitting is essential for creating three-way, angular and zigzag layouts. L: 25 1/2" - W: 25 1/2" - H: 17 3/4". Made from thick POLYETHYLENE.

04 712 each

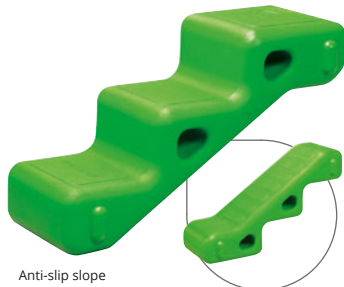

Anti-slip slope

ALFRESCO STAIRS/SLOPE This block can be used at the start or end of an obstacle course. It easily slots into the H or Y shaped blocks whichever way up it is turned to become a set of 3 stairs or a slope. L: 29 1/2" - W: 11 3/4" - H: 17 3/4". Made from thick POLYETHYLENE.

00 828 each



ALFRESCO BRIDGE These can be used on the ground, with a wheel or on a beam, either as obstacles or to make a rocker see-saw. L: 15 3/4" - W: 11 3/4" - H: 11 3/4". Made from thick POLYETHYLENE.

04 705 each

ALFRESCO



3 YEAR GUARANTEE

MADE IN CANADA

Complies with standard
NFS 54-300 :
motor activity safety
Phthalate-free.
Comes with a teacher's
leaflet



3 to 6 years
for use under adult supervision



A

A ALFRESCO STRAIGHT BEAM Rigid and very robust, it is easy to position in the fittings and can hold mini-bridges. L: 47 1/4" - W: 11 3/4" - H: 6". Made from thick POLYETHYLENE.

04 704 each

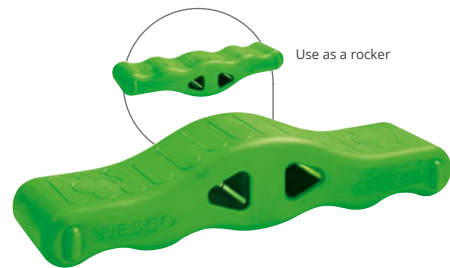

Use as a rocker

B

B OXYGEN WAVE BEAM Derived from the beam, this block can be used on its own or between two slot-in blocks. On one side there is one large wave and on the other side there are several small waves. When placed on the ground it can be used as a small seesaw. L: 47 1/4" - W: 11 3/4" - H: 9 3/4". Made from thick POLYETHYLENE.

00 829 each

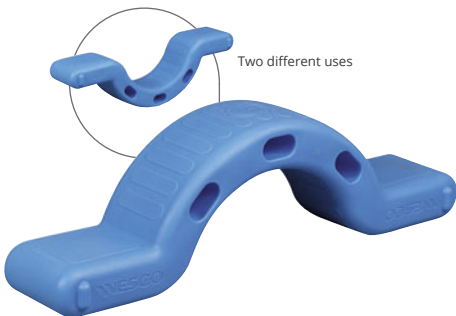

Two different uses

C

C ALFRESCO CURVED BEAM This beam can be used on its own (placed directly on the floor) or as part of a course (with connecting pieces). Used independently it forms either a large arch for children to climb over, or a large seesaw. When used with other blocks children can create challenging ascending and descending courses. L: 59" - l: 11 3/4" - H: 17 3/4". Made from thick POLYETHYLENE.

12 250 each

D ALFRESCO TUNNEL BEAM This item is a combination of the beam and the wheel. When positioned between 2 slot-in blocks, it can be crossed in 2 different ways: through the inside (like a tunnel) or over the top. The top obstacle's height varies depending on which way up the beam is placed. It can also be used on its own as a see-saw. Equally, depending on the way it is positioned, it can be used by children of different sizes. L: 47 1/4" - W: 11 3/4" - H: 23 1/2" - Ø of hole 15 3/4". Made from thick POLYETHYLENE.

00 875 each

E ALFRESCO WHEEL This wheel is fitted with little studs and is one of the essential items in this range. It can be used in several different ways. On its own, you can steer it and roll it along. When stacked with other wheels to form a larger unit, held together by its built-in assembly studs, children can hide inside. Alternatively, when supported horizontally by two mini-bridges, children can wriggle through it. th: 11 3/4" - Aperture Ø 15 3/4" - overall Ø 27 1/2". Made from thick POLYETHYLENE.

04 713 each



The asymmetrical design allows 2 different tunnel heights.



D



E



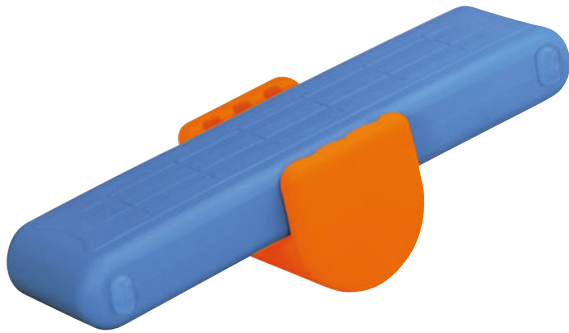

ALFRESCO SEESAW KIT Consists of: 2 pieces: 1 bridge, 1 straight beam. Floor space: 47 1/4" x 15 3/4". Made from thick POLYETHYLENE. Comes with a teacher's leaflet

38 556

set



OXYGEN BRIDGE KIT Consists of: 3 pieces: 1 tunnel fitting, 1 right beam, 1 wave beam. Floor space: 110 1/4" x 23 1/2". Made from thick POLYETHYLENE. Comes with a teacher's leaflet

38 560

set

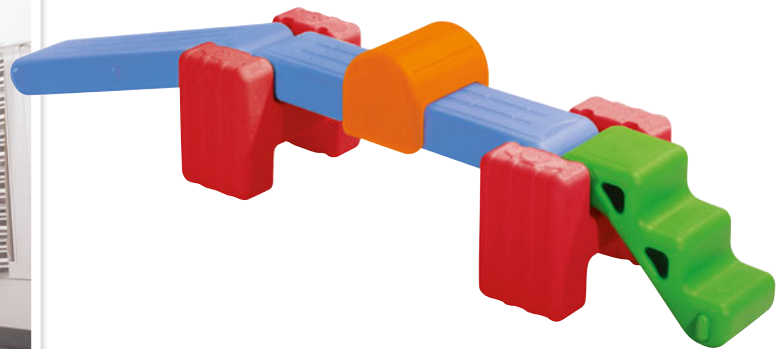

ALFRESCO OBSTACLE COURSE KIT Consists of: 6 pieces: 2 H blocks, 2 right beams, 1 sloping staircase, 1 bridge. Floor space: 118" x 23 1/2". Made from thick POLYETHYLENE. Comes with a teacher's leaflet

38 553

set



OXYGEN KIT 1 ENTRANCE, 2 EXITS Consists of: 8 pieces: 2 H block, 1 Y block, 1 beam, 1 sloping staircase, 1 wave beam, 1 tunnel beam, 1 bridge. Floor space: Ø 118". Made from thick POLYETHYLENE. Comes with a teacher's leaflet

38 554

set



THE CAVE ALFRESCO KIT Consists of: 18 pieces:
 3 wheels, 6 bridges, 4 H block, 1 right beam, 1 tunnel
 beam, 1 sloping staircase, 2 curved beams. Floor
 space: 173 1/4" x 124". Made from thick
 POLYETHYLENE. Comes with a teacher's leaflet
 38 558 set



THE CREST ALFRESCO KIT Consists of: 11 pieces:
 2 Y blocks, 2 sloping staircases, 1 tunnel beam,
 1 H blocks, 1 tunnel fitting, 1 wave beam, 3 curved
 beams. Floor space: 151 1/2" x 67". Made from thick
 POLYETHYLENE. Comes with a teacher's leaflet
 38 559 set



3 YEAR GUARANTEE

MADE IN EUROPE

Complies with standard
NFS 54-300 : motor
activity safety

Phthalate-free.

2 to 6 years
for use under adult supervision

The TACTIK Scogym range has been devised to meet the needs of children to test their limits and conquer their fears. These experiences will enable children to gain confidence and attempt new course layouts. It has been designed to develop a child's sense of balance, stimulate their sense of touch, observation, co-ordination and to strengthen muscles. The range is fully modular enabling group learning processes.

- +** The wooden and plastic modules are compatible!
- Stable:** guaranteed due to wide, single-piece blocks.
- Sturdy:** specially designed for motor skills activities and intensive use.
- Safe:** non-slip base, no sharp edges.
- Hygienic:** easy to clean with a cloth and our cleaning product.
- Easy assembly:** simple clip-on fixing.
- Highly modular:** for building courses.

TACTIK SCOGYM range

Enjoy new sensory experiences!



Level 1 :

Very close to the ground, these motor skill exercises provide reassurance for the youngest children. To be played preferably with bare feet in order to enhance sensation and body awareness.



Level 2 :

Go up, down, over... The circuits are higher and more undulating to practise motor skills.



Level 2: higher circuits with sloping surfaces for progressive difficulty

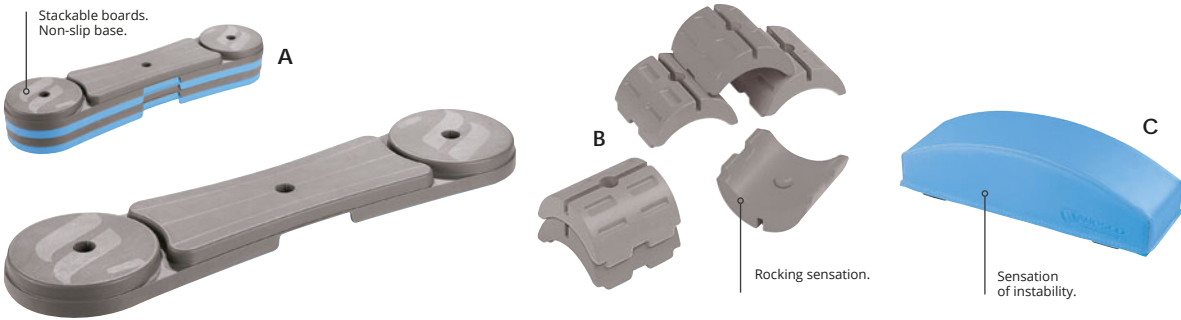

A TACTIK Scogym BOARD	L: 34" - W: 8 1/4" - H: 1 3/4".	●● Choice of colours: BLUE (002) - GREY (006)	41 215	each
B TACTIK Scogym EQUILIBLOC	Side: 5 1/2" - H: 2 3/4" - max th: 1 1/2".		32 014	pack of 2
C TACTIK Scogym WAVE	L: 15 3/4" - W: 5" - H: 4".		41 281	each

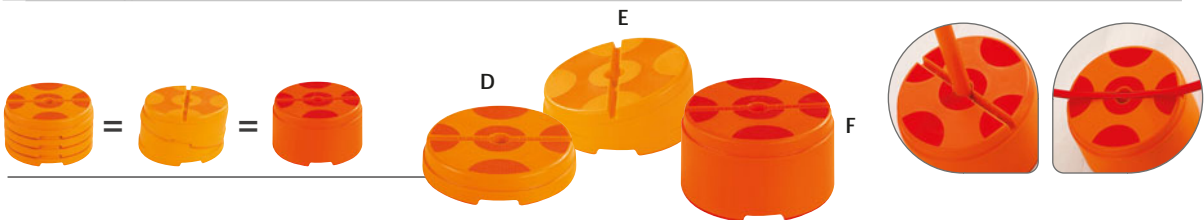

D TACTIK Scogym SMALL BLOCK	Height: 1 3/4" - Ø 8 1/4".	41 217	each
E TACTIK Scogym SLOPED BLOCK	Height: 3 3/4" - Ø 8 1/4".	41 216	each
F TACTIK Scogym LARGE BLOCK	Height: 4 3/4" - Ø 8 1/4".	41 244	each

Made from thick POLYETHYLENE. Washable with water. For indoor and outdoor use.

Level 2: higher circuits with sloping surfaces for progressive difficulty



46-piece TACTIK Scogym KIT Consists of: 3 small blocks, 3 large blocks, 3 rings: Ø 7", 3 hoops: Ø 13 3/4", 3 hoops: Ø 23 1/2", 1 1/2 x 11 3/4" poles, 3 1/4 x 27 1/2" poles, 1 set of 6 double clips for poles, 1 set of 6 double clips for hoops, 1 set of 4 arrow ground markings, 2 x 5 m ropes and 1 storage case. Made from thick POLYETHYLENE. For indoor and outdoor use. Supplied with an educational booklet.

41 321 set



47-piece TACTIK Scogym KIT Consists of: 2 small blocks, 2 sloped blocks, 2 large blocks, 2 x Ø 13 3/4" hoops, 6 x Ø 19 3/4" hoops, 6 1/4 x 27 1/2" batons, 1 set of 6 double clips for batons, 1 set of 6 double clips for hoops and 1 storage case. Made from thick POLYETHYLENE. For indoor and outdoor use. Supplied with an educational booklet.

66 254 set



34 piece TACTIK Scogym KIT Consists of: 3 boards, 4 small blocks, 2 sloped blocks, 2 large blocks, 4 hoops: Ø 19 3/4", 1 1/2 x 39 1/4" poles, 1 set of 6 double clips for hoops, 1 set of 6 double clips for poles, 1 set of 2 equilibrioblocks and 1 storage case. Made from thick POLYETHYLENE. For indoor and outdoor use. Supplied with an educational booklet.

41 327 set



26 piece TACTIK Scogym KIT Consists of: 5 boards, 6 small blocks, 2 sloped blocks, 4 large blocks, 2 hoops: Ø 23 1/2", 1 1/2 x 39 1/4" poles, 1 set of 2 equilibrioblocks and 1 storage case. Made from thick POLYETHYLENE. For indoor and outdoor use. Supplied with an educational booklet.

41 324 set



41 piece TACTIK Scogym KIT Consists of: 5 boards, 10 small blocks, 2 sloped blocks, 4 large blocks, 2 hoops: Ø 23 1/2", 1 1/4 x 39 1/4" poles, 1 set of 6 double clips for poles, 1 set of 6 double clips for hoops, 1 set of 2 equilibrioblocks, 1 wave and 1 storage case. Made from thick POLYETHYLENE. For indoor and outdoor use. Supplied with an educational booklet.

41 325 set



45 piece TACTIK Scogym KIT Consists of: 7 boards, 10 small blocks, 2 sloped blocks, 4 large blocks, 2 hoops: Ø 23 1/2", 1 1/2 x 39 1/4" poles, 1 set of 6 double clips for poles, 1 set of 6 double clips for hoops, 1 set of 2 equilibrioblocks, 1 wave and 1 storage case. Made from thick POLYETHYLENE. For indoor and outdoor use. Supplied with an educational booklet.

41 329 set

wesco
design

GUARANTEE 2-YEARS
except accessories

MADE IN FRANCE

Supplied with an educational booklet.
Comes assembled.

for use under adult supervision
The wearing of protective gear is strongly recommended.

Ovi'Slide motor skills board

- +** **Pedagogy:** many group activities possible.
- Safety:** no sharp corners. Rolling mechanism out of reach of hands.
- Ergonomics:** very compact.



A



B

A + 3 years

Ovi'Slide motor skills board The motor skills board was designed to enhance body awareness and the idea of risk-taking. When instructed to find the best position to "control" the board, children can move around seated or lying down. Used individually or connected together, these Ovi'Slide boards support various motor skills activities that are both fun and technical. Maximum weight capacity: 110,2 lbs. L: 24 1/2" - W: 20 3/4" - H: 8 3/4". Made from PLASTIC. For indoor and outdoor use. Supplied with an educational booklet. Comes assembled. Choice of colours: BLUE (002) - LIGHT GREEN (037) - LIGHT ORANGE (164) - RED (011)

45 287 each



Ovi'Slide PADDLE
L: 33". Made from PLASTIC.

45 314 each



Ovi'slide PULLING ROPE
L: 2 m. Made from soft POLYPROPYLENE.

45 959 each



Ovi'Slide COMPLETE KIT Consists of: 1 Ovi'Slide board, 1 pulling rope L: 2 m and 1 Ovi'Slide paddle. Panel: L: 24 1/2" - W: 20 3/4" - H: 8 3/4". Paddle: L: 33". Made from PLASTIC. Supplied with an educational booklet. Choice of colours: BLUE (002) - LIGHT GREEN (037) - LIGHT ORANGE (164) - RED (011)

54 112 set



Ovi'slide 2 PEOPLE KIT Consists of: 2 Ovi'slide motor skill boards, 2 Ovi'Slide paddles, 12 perforated cones H: 12 1/2" in assorted colours, 6 batons (L: 39 1/4", assorted colours), 6 clips for double directional batons and 2 pulling ropes (1 rope: L: 2 m). Made from PLASTIC. For indoor and outdoor use. Supplied with an educational booklet.

45 315 set

B + 2 years

WAVY BALANCE BOARD Standing, sitting or lying down, children will have to find their balance and co-ordinate their movements. Equipped with finger-friendly handles, Wavy allows the child to safely develop their motor skills. L: 22 3/4" - W: 15" - H: 6 3/4". Made from thick POLYETHYLENE. washable with water. For indoor and outdoor use. Comes with a plastic ball. Choice of colours: BLUE (002) - LIGHT GREEN (037) - LIGHT ORANGE (164)

55 994 set



C

Undetachable fixed ends
Made from ABS plastic,
they are highly resistant.

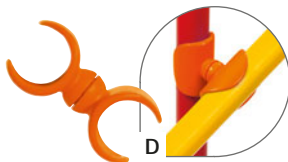

D

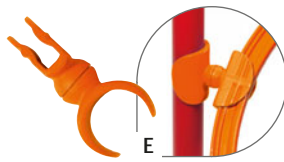

E

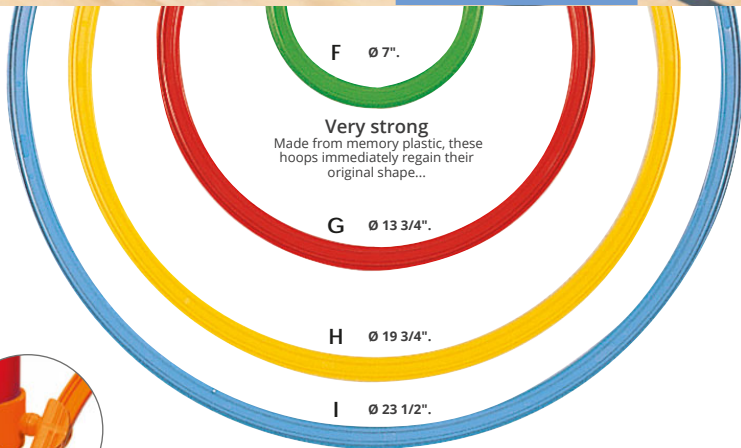

F Ø 7".

Very strong
Made from memory plastic, these
hoops immediately regain their
original shape...

G Ø 13 3/4".

H Ø 19 3/4".

I Ø 23 1/2".

C BATONS Ø1". Choice of colours: PURPLE (034) - BLUE (002) - GREEN (008) - YELLOW (014) - ORANGE (007) - RED (011)

Length 11 3/4"	25 239	each
Length 27 1/2"	25 240	each
Length 39 1/4"	25 241	each
Length 51 1/4"	25 242	each
Length 70 3/4"	25 243	each

D DOUBLE ROTATING CLIPS FOR BATONS
They enable all of our 1" Ø batons and markers to be linked together. Made from PLASTIC. Colours ORANGE (007)

00 143 pack of 6

E DOUBLE ROTATING CLIPS FOR HOOPS
They are used to attach our hoops to the Ø 1" batons and poles. Made from PLASTIC. Colours ORANGE (007)

00 142 pack of 6

FLAT HOOP Choice of colours: PURPLE (034) - BLUE (002) - GREEN (008) - YELLOW (014) - ORANGE (007) - RED (011)

F Ø 7"	00 195	each
G Ø 13 3/4"	00 196	each
H Ø 19 3/4"	00 197	each
I Ø 23 1/2"	00 198	each



2 YEAR GUARANTEE

MADE IN CANADA

Phthalate-free.
For indoor exercises only

Gymnastic and development mats

Firm foam mats for floor exercises and fighting sports

Tumbling mats are designed to be used to form a line or large tumbling area. They can be placed side by side on the floor for fun activities to practise motor skills such as : gymnastics, dance, judo, games...



Ultra-firm, 1,5 lbs/ft3 density, Tatami judo-type polyethylene foam.

Hygienic: the vinyl fabric is easy to clean with either a soft cloth or sponge and cold soapy water.

Our embroidered stitching makes them airtight and prevents access to the inside.

Fitted with a **non-slip base**.



TUMBLING MAT Made from Ultra-firm polyethylene foam Choice of colours: BLUE (214) - GREEN (008) - ORANGE (216) - RED (217)

each

A	L: 78 3/4" - W: 39 1/4" - Thickness: 1 1/2"	34 338
B	L: 39 1/4" - W: 39 1/4" - Thickness: 1 1/2"	20 198
	L: 78 3/4" - W: 39 1/4" - Thickness: 1 1/2"	34 339

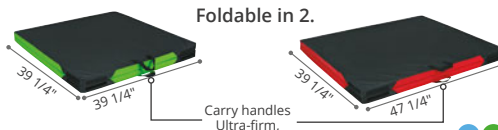

Foldable TUMBLING MAT Made from Ultra-firm polyethylene foam Choice of colours: BLUE (214) - GREEN (008) - ORANGE (216) - RED (217)

each

C	L: 78 3/4" - W: 39 1/4" - Thickness: 1 1/2"	20 199
	L: 78 3/4" - W: 47 1/4" - Thickness: 1 1/2"	20 200

D
Foldable TUMBLING MAT Consists of: 3 folding tumbling mats (1 orange/red, 1 green and 1 blue). Made from Ultra-firm polyethylene foam Colours MULTICOLOURED (020)

each

L: 70 3/4" - W: 47 1/4" - th: 1 1/2"	34 342
---	---------------

- folds in 3



Choice of colours: MULTICOLOURED (020) - GREEN/LIGHT GREEN (169) - BLUE/LIGHT BLUE (218) - RED/ORANGE (221)

each

L: 94 1/2" - W: 47 1/4" - th: 1 1/2"	34 343
---	---------------

- folds in 4

FOLDABLE TUMBLING MAT MAXI PACK L: 94 1/2" - W: 47 1/4" - th: 1 1/2"



34 473

pack of 3

E
PATHWAY EVOLUTION MAT Made from POLYURETHANE FOAM. Choice of colours: BLUE/LIGHT BLUE (218) - RED/ORANGE (221)

each

L: 78 3/4" - W: 39 1/4" - th: 1 1/2"	34 345
---	---------------

Pathway TUMBLING MAT MAXI PACK L: 78 3/4" - W: 39 1/4" - th: 1 1/2"



34 346

pack of 3

F
Foldable LARGE DEVELOPMENT AREA Made from POLYURETHANE FOAM. Colours ORANGE (216)

each

L: 94 1/2" - W: 94 1/2" - th: 1 1/2"	34 344
---	---------------

Folds in 4: L: 23 1/2" - W: 94 1/2" - th: 6 1/4"

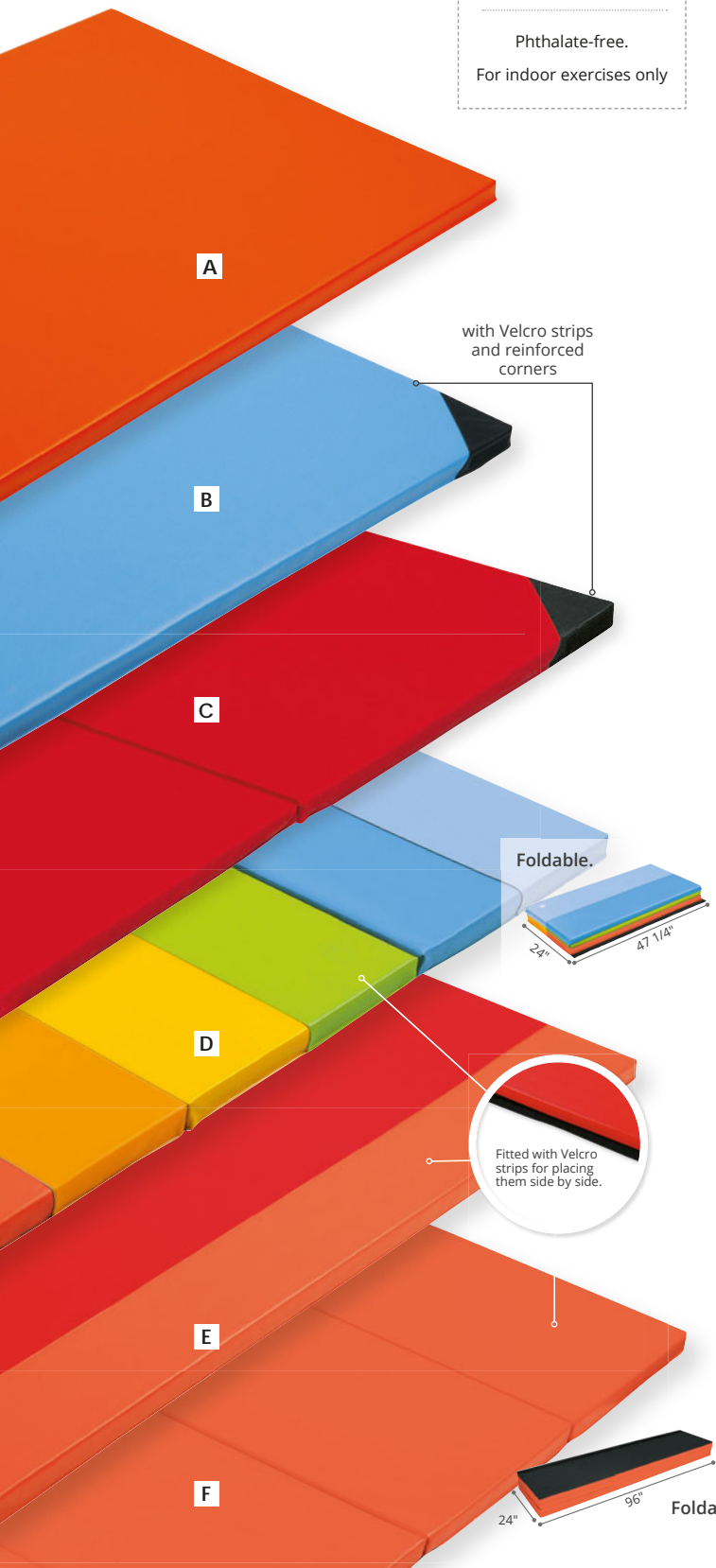

with Velcro strips and reinforced corners

Foldable.

Fitted with Velcro strips for placing them side by side.

Foldable in 4

Landing mats

These mats are recommended for landing and for absorbing shocks from jumping. When protected by these mats children can do their gymnastic exercises without fear of falling.

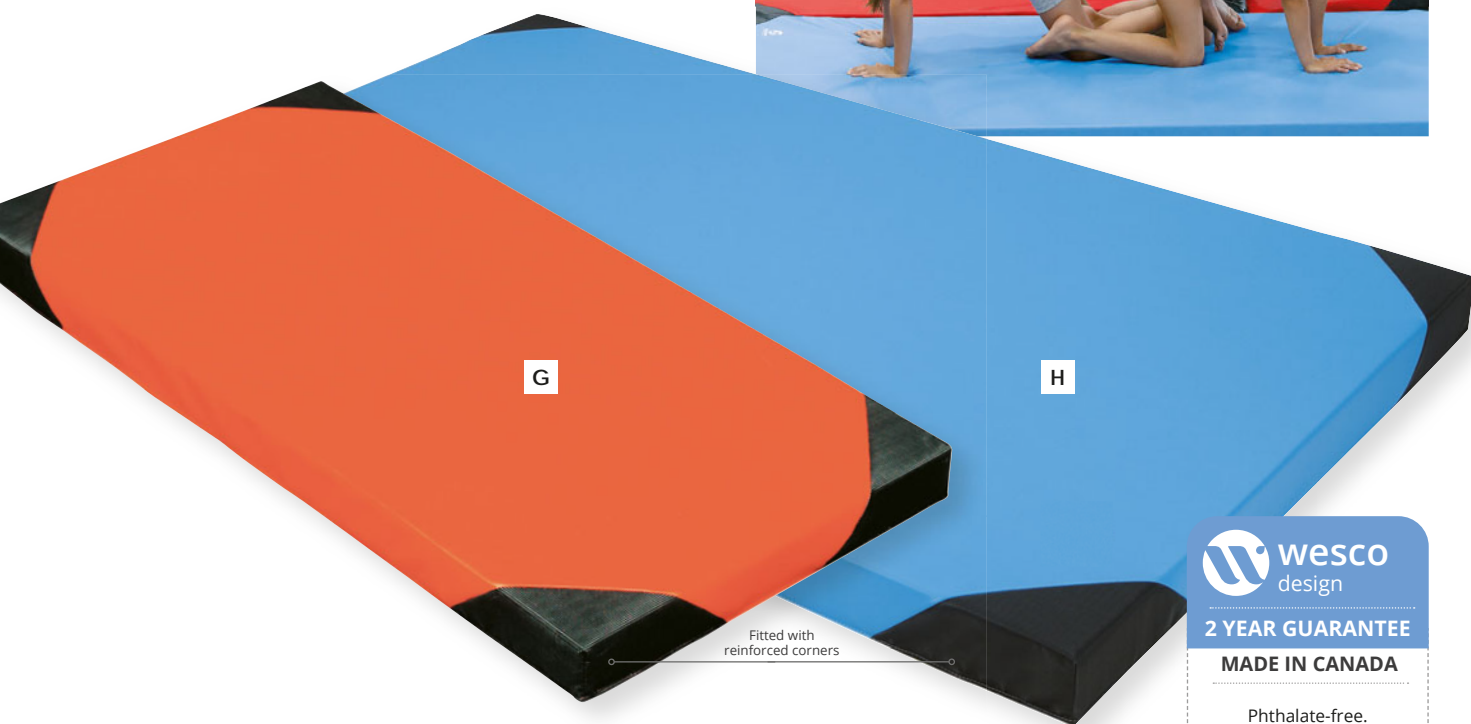

wesco
 design
2 YEAR GUARANTEE
MADE IN CANADA
 Phthalate-free.
 For indoor exercises only

G LANDING MATS Choice of colours: BLUE (214) - GREEN (008) - ORANGE (216) - RED (217)

L: 47 1/4" - W: 23 1/2" - **Th: 2 3/4"**

L: 70 3/4" - W: 23 1/2" - **th: 2 3/4"**

L: 78 3/4" - W: 39 1/4" - **th: 2 3/4"**

L: 78 3/4" - W: 47 1/4" - **th: 2 3/4"**

L: 78 3/4" - W: 39 1/4" - **th: 2 3/4"** - Folds in 2



00 123

00 146

00 761

00 762

20 201

each

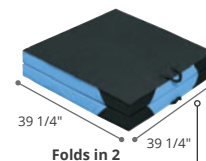

H LANDING MATS Choice of colours: BLUE (214) - GREEN (008) - RED (217)

L: 47 1/4" - W: 78 3/4" - **th: 4"**

L: 47 1/4" - W: 78 3/4" - **th: 4"** - Folds in 2



20 202

20 203

each

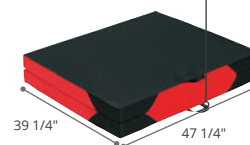

My first wheeled toys

Learning to balance, step by step...



High resistance: made from very thick plastic and fitted with solid puncture-proof wheels.

Hygienic: they can be easily cleaned and disinfected.

Safety: no sharp corners, rounded handles, no space between the pieces. Anti-finger-trapping wheels.

Designed for intensive use: do not mark floors.



A



B



C

wesco design
2 YEAR GUARANTEE
MADE IN CANADA
 Complies with toy standards: EN 71 1, 2 and 3
 Phthalate-free.
 Comes assembled.
 for use under adult supervision
 All of our products need to be used under adult supervision.

Vehicle with fixed wheels



Biosourced materials.
100% recyclable.

Presto

Wide, low and very stable

Illico

Narrow and easy to manoeuvre

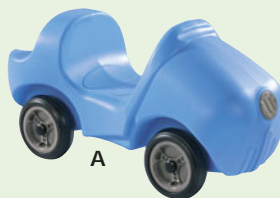

A



B

+ 12 months

Wide seat.
High-backed very reassuring for beginners.

+ 18 months

Unrestricted area for the legs.
Support handles.

Made from BIO-SOURCED MATERIAL. Washable with water. For indoor and outdoor use. Comes assembled.

each

A	Bio-sourced PRESTO RIDE-ON TOY	L: 27 1/2" - W: 11 3/4" - Total H: 15 3/4". Seat H: 7 1/2".	● BLUE (002) - GREEN (008)	57 487
B	Bio-sourced ILLICO RIDE-ON TOY	L: 21 1/2" - W: 9 1/2" - Total H: 17". Seat H: 9 3/4".	● LIGHT BLUE (057) - LIGHT GREEN (037)	57 486

C Made from thick POLYETHYLENE. Washable with water. For indoor and outdoor use. Comes assembled. Choice of colours: LIGHT BLUE (057) - RED (011) - PURPLE (034) each

RAPIDO PUSHALONG	+ 12 months	L: 25 1/4" - W: 13 1/4" - H: 15 1/4" - Seat height 7 3/4"	00 455
-------------------------	-------------	---	--------



FIRST RIDE-ONS KIT for 12 - 18 months
 Consists of: 1 light blue Illico, 1 green Presto and 1 red/orange Dynamo. Presto: L: 27 1/2" - W: 11 3/4" - H: 15 3/4". Seat H: 7 1/2". Made from thick POLYETHYLENE. For indoor and outdoor use. Comes assembled.

57 835 pack of 3

Vehicles with steering mechanism

100% recyclable.
 Illico

Presto
Ergonomic and sturdy.



D

+ 18 months

Fitted with a handle at the back.
 Knee rests on the back to develop motor skills.
 Front wheel steering thanks to the steering wheel.



E

+ 18 months

High quality heat-applied graphic:
 does not peel off, does not discolour.

Oto-mobile
Compact, fun and easy to manoeuvre

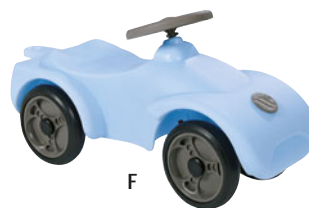

F

+ 18 months

Space at the back to put your knees and encourage fine motor skills.
 Steering wheel and directional wheels.
 Integrated tow-bar.

Made from thick POLYETHYLENE. Washable with water. For indoor and outdoor use. Comes assembled.

each

D	LOCO PUSHALONG L: 29 3/4" - W: 13" - Total H: 16 1/4". Seat H: 11".		PURPLE (034) - LIGHT GREEN (037) - YELLOW (014)	44 884
E	DYNAMO PUSHALONG L: 28 1/2" - W: 12 1/4" - Total H: 17 1/4". Seat H: 9 1/2".		GREEN/LIGHT GREEN (169) - BLUE/LIGHT BLUE (059) - RED/ORANGE (039)	41 503
F	1-SEATER OTO-MOBILE L: 27 3/4" - W: 11" - H: 13 3/4". Seat H: 9 1/4".		LIGHT BLUE (057) - LIGHT GREEN (037) - LIGHT ORANGE (164)	56 015

It's more fun when there are more of you!



"Crazy" wheels at the back for spinning around!

+ 18 months
AIRPLANE DOUBLE PUSHALONG
 Can be used by one or two children. The low height of the seats and their ergonomic design makes this perfect for very young children. This allows them to develop their balance in complete safety. L: 34 1/4" - W: 25 1/4" - H: 15 1/4" - Seat H: 8 3/4". Made from thick POLYETHYLENE. For indoor and outdoor use. Comes assembled. Choice of colours: LIGHT BLUE (057) - LIGHT GREEN (037)

50 921 each



Learning to balance, step by step...



Motorbike
 Ergonomic for better positioning of the legs.



Limited directional handlebar rotation (90°) with a riding position is similar to that of a bicycle.

High quality heat-applied graphic: does not peel off, does not discolour.

2 to 5 years

MOTORCYCLE L: 25 1/4" - Total H: 20 3/4". Seat H: 13". washable with water. For indoor and outdoor use. Comes assembled.

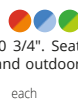

each

A Green	39 441
B Magic	39 442
C Star	39 439
D Police	39 438
E Race	40 286



MAXI PACK Sporty appearance MOTORCYCLES
 L: 25 1/4" - Total H: 20 3/4".
 Seat H: 13".

40 287 pack of 3



MAXI PACK MOTORBIKES
 L: 25 1/4" - Total H: 20 3/4".
 Seat H: 13".

39 448 pack of 3

wesco
design

3 YEAR GUARANTEE

Complies with toy standards:
EN 71 1, 2 and 3

A wheelbarrow for any age!

Ideal for learning how to balance with 2 wheels then 1 wheel, while enjoying carrying toys, water or sand.



All our wheelbarrow models of the same size are stackable.



Single piece, ultra-resistant, stackable



100% recyclable.



F



G



H Large capacity

F + 12 months

MY FIRST WHEELBARROW Small, very lightweight and extremely handy, this pretty wheelbarrow will entertain young children, while improving their balance. L: 21 3/4" - W: 11 1/4" - H. handles: 11 3/4". Made from thick POLYETHYLENE. For indoor and outdoor use. Colours LIGHT GREEN (037)

54 088

each

G

WHEELBARROW L: 24 3/4" - W: 13 3/4" - H. handles: 11 3/4". For indoor and outdoor use. Choice of colours: BLUE (002) - GREEN (008) - ORANGE (007)

2 WHEELS + 12 months 41 348

1 WHEEL + 18 months 41 343

H

LARGE WHEELBARROW L: 31" - W: 17 1/2" - H. handles: 15 3/4". For indoor and outdoor use. Choice of colours: BLUE (002) - GREEN (008) - ORANGE (007)

2 WHEELS + 18 months 12 359

1 WHEEL + 2 years 12 360

wesco
design

3 YEAR GUARANTEE

MADE IN FRANCE



Clever: connecting system to easily link the trolleys together. Stackable.

Hygienic: can be entirely cleaned with water.

Safe: all edges are rounded. Full rims with anti-finger jamming.



100% recyclable.



Large capacity:
9,24 gal.

Wide and
puncture-proof
wheels.



+ 18 months

Loco TROLLEY / STORAGE TRAY With handle Consists of: 1 Loco trolley and handle. L: 26 3/4" - W: 19 1/4" - H: 14 1/4" Made from thick POLYETHYLENE, washable with water. For indoor and outdoor use. Choice of colours: BLUE (002) - LIGHT GREEN (037) - LIGHT ORANGE (164)

56 185

set



+ 18 months

Loco TROLLEY / STORAGE TRAY Without handle L: 26 3/4" - W: 19 1/4" - H: 14 1/4" Made from thick POLYETHYLENE, washable with water. For indoor and outdoor use. Choice of colours: BLUE (002) - LIGHT GREEN (037) - LIGHT ORANGE (164)

56 184

each



The handle is easily stored inside the trolley.



+ 18 months

Loco SMALL TRAIN Consists of: 3 Loco trolleys and 1 handle. L: 73 1/2" - W: 19 1/4" - H: 14 1/4". Made from thick POLYETHYLENE, washable with water. For indoor and outdoor use. Choice of colours: BLUE (002) - LIGHT GREEN (037) - LIGHT ORANGE (164) - MULTICOLOURED (020)

56 186

set

Large capacity:
27,72 gal (3 x 9,24 gal).

LUMA cabin

Children love cabins for hiding away and creating their own cosy little space.



Ultra strong:

Thick walls (2 1/4")

100% recycled boards, weather and rot resistant. ANTI-UV treated for increased strength over time

Large size:

2 x 3 seater benches included

Large windows for optimal monitoring

It is possible to fix the cabin to the ground



Luma LARGE CABIN With this large Luma cabin, children will enjoy real adventures in THEIR house at the bottom of the garden. It will delight children who will use it to come up with the loveliest stories. Consists of: 2 windows and 2 x 3-seater benches included. L: 60 3/4" - W: 55" - H: 64 1/4". Weight: 110,2 lbs. Made from thick POLYETHYLENE. washable with a sponge. For indoor and outdoor use. Delivered flat-packed, do-it-yourself installation. Choice of colours: BLUE (002) - LIGHT GREEN (037) - LIGHT ORANGE (164)

45 316

each

Go out with complete peace of mind!



Padded handles for extra comfort. Handles for adults at the front and back.

+ 18 months

COLOURED WALKING ROPES Made from FABRIC (decorations) and VINYL FABRIC (Strap: base and handle). washable : disinfectant on the surface.

A For 6 children	L: 97 1/2".	59 357	each
B For 12 children	L: 175".	59 541	each

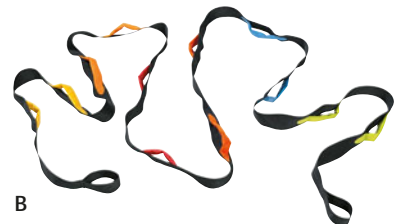

Open or shaded ELYO structures

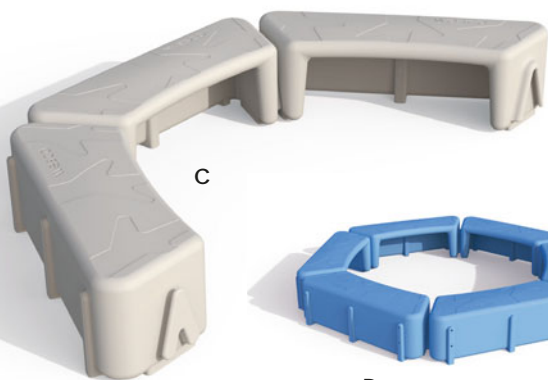

C



D



E

C PACK of 3 Elyo BENCHES Consists of: 3 benches, 6 plates and fixings. Ground space: L: 39 1/4" - W: 13 1/2" - Seat H: 12 1/4". Made from thick POLYETHYLENE. Supplied with mounting screws. Choice of colours: BLUE (002) - LIGHT GREEN (037) - GREY (006)

58 581 pack of 3

D PACK of 6 Elyo BENCHES Consists of: 6 benches, 12 plates and fixings. Ground space: L: 88 1/2" - W: 80" - Seat H: 12 1/4". Made from thick POLYETHYLENE. Supplied with mounting screws. Choice of colours: BLUE (002) - LIGHT GREEN (037) - GREY (006)

58 579 pack of 6

E Elyo MEETUP Consists of: 6 benches, 1 table, 15 plates and fixings. Ground space: L: 88 1/2" - W: 80" - Seat H: 12 1/4". Made from thick POLYETHYLENE. Supplied with mounting screws. Table to be anchored to the ground. Choice of colours: BLUE (002) - LIGHT GREEN (037)

58 577 set

F Elyo SHADED MEETUP The ELYO meetup is useful for gathering children together in one place for snacking or an activity in a shady area. Fixing supplied with the structure. Consists of: 6 benches, 1 table, 15 plates, 1 tree and fixings. Ground space: L: 88 1/2" - W: 80" - Seat H: 12 1/4". Highest clearance height: 83 1/2". Lowest clearance height: 67". Span: 153 1/2". Made from Thick POLYETHYLENE. Delivered flat-packed, do-it-yourself installation. Choice of colours: BLUE (002) - LIGHT GREEN (037)

58 564 set



F



G

G Elyo TREE SHADE STRUCTURE The tree shade structure is a totem which provides a shady area in the playground but also serves as a meeting point. It can be combined with the Elyo table. The tree MUST be anchored to the ground by means of an anchoring system. Fixing supplied with the structure. Consists of: 1 tree, 1 fabric canopy Ground space: L: 10 1/4" - W: 9 3/4". Highest clearance height: 83 1/2". Lowest clearance height: 67". Span: 153 1/2". Made from Hot-dip galvanised METAL with EPOXY finish. METAL Flat-packed, to be assembled by a professional. Colours LIGHT GREY (180)

58 575 each



Elyo BENCH It has an integral goal, so no need for children to be left on the subs bench! Consists of: 1 bench, 2 plates and fixings. Ground space: L: 39 1/4" - W: 13 1/2" - Seat H: 12 1/4". Made from thick POLYETHYLENE. Supplied with mounting screws. Choice of colours: BLUE (002) - LIGHT GREEN (037) - GREY (006)

58 586 each

ELYO accessories



Elyo TABLE Size 2 table ideal for school playgrounds. It can be used alone or with the Elyo tree shade structure but can also be fixed to the ground with mounting plates. To be anchored to the ground. Consists of: 1 table, 3 plates and fixings. Ground space: L: 46 1/2" - W: 43 1/4" - H: 20 3/4" Made from thick POLYETHYLENE. Supplied with mounting screws. Choice of colours: BLUE (002) - LIGHT GREEN (037)

58 585 each

Index

alphabetical



A - B - C

Activity areas	18-19, 38-40
Alfresco Range	98-102
"Archibloc" (construction)	54-55
A space to relax, read and play	18-41
Babiboost (walker)	56
Babi Up Cabin	41
BABlXplore range (motor skills)	90-91
Baby Mats	58-59
"Babyseat" mats (relaxation areas)	18-19
Babyseats range	18-19
Balancing Turtle	6
Ball pools	66-69
Balls for ball pools	67,69
Basic range	8, 25-31
Basic range natural colour	28-29
Basic range (vinyl)	2, 8, 26-27, 29, 31-32, 36
Batons	107
Bio-based basic range	30-31
BLOCmodules (motor skills)	82-88
Blocmodules Range	82-88
Cardboard bricks	54-55
Changing mat	48
Climb Up Range	89
Club range	32-33
Cocoon range	46
Contour mattress	46
Costumes	52
Creating spaces	42-45

D - E - F

Deckchair	7, 16
Decofoam	49
Delta Range	34-35
Early learning mats	58-61
Easels	10
Elyo Range	115
Explor'ation	92-97
Flexible seating	7
Floor beds	47

Floor protector mats	58-65
Flora plastic furniture	13
Flora range	13
Foam cabin	3, 7

G - H - K - L

GAMES	50-55
Giant constructions	54-55
Giant cushions	50-51
Gym mats	108-109
Gymnastic/development mats	108-109
Hexagon activity panels	53
Hoops	107
Horseshoe mats	17
Kia range	9, 36
Kia rocking chair	9, 36
Kidy S'cool new	35
Landing mats	108-109
Large construction blocks	54-55
LAYOUT AND FURNITURE	2-49
Liloo range	37
Lotus Ball pools	69
Luma cabin new	114
Luna range	37

M - N - O - P

Made to measure mats	48
Mobile room dividers	45
Mosaic Range	38-39
"Mosaic" Mats	38-39, 62-63
Nidoo	21
Ovi'Slide motor skills board	106
Painting aprons	11
Pear (seat)	3, 21
Pilouface new	12
Pouffes	22-23
Protection (Changing area)	48
Pushalongs	110-112

R - S

Reception area	8-9
Rest area	46-47
Rezistatoo rug range	24
Rockers	57
Round seat pads	22-23
Rugs	24, 58-65
Rugs and mats	58-65, 108-109
Scogym (motor skills)	103-105
Seaty Cushions	20
Seaty Range	20
Sensory and motor skill development	17, 50-51
Sensory range	5-6, 80
Sensory space	2-6
Smocks	11
Snoezelen Sensory Room	2-3
SPORT AND MOTOR SKILLS	56-115
Support cushions	17

T - U - V - W

Tadam range New	14-15
Tic Tac Range	36
Tiny Tot modules (motor skills)	71-81
Tiny Tot Modules Range	71-79
Tio'la range	40
Totem Tray	37
"Ublo" barriers	42-44
Vinyl benches	8, 12, 26, 29
Walking accessories	114
Walking ropes	114
Walking trolley	56
Wall protector mats	58-59
Wheelbarrows	113
Wheeled toys	110-112
White furniture	2-3



Bio-sourced ILLICO RIDE-ON TOY

+ 18 months

With this very manoeuvrable little vehicle and a high seat, children will easily find their ideal position to learn about balance in complete safety.



Serving
you for
45 years!



1976



1987



1993



1997



2006



2011



2017

This document is not contractual. Slight differences in shapes and colours may occur between the products and their reproduction. In order to improve products, the manufacturers reserve the right to alter specifications without prior notice. E.V.O.E. - According to Article L.335-2 of French Intellectual Property Laws, all written, drawn, painted or any other form of printed or engraved publications, whole or in part, in contempt of the laws and regulations related to author ownerships is counterfeit. Counterfeiting is a crime punishable by imprisonment and a fine — the delivery, export and import of counterfeit objects are subject to the same penalties. Please do not litter.

Conception and production : WESCO. Photos : WESCO. Photo/Chroma retouching: Arco Iris
Printed in Canada.
MARCH 2024 - © WESCO 2024. WESCO N.A. Inc, Princeville, QC, G6L 5R2, Canada and Wesco S.A. France.

wesco®

Creating a world for children for over 45 years

www.wescona.com

WESCO
is member of



WESCO north america inc.

CORPORATE OFFICE :
770 St Henri
Princeville, QC, G6L 5R2

DISTRIBUTION CENTER :
1 UPS Way
Champlain, NY, 12919

For immediate assistance please contact us :
Toll free : 1-888-364-2644 - Fax : 1-888-364-3417
Email : info@wescona.com



New
BABIMODULES MINI
*Special
for small spaces*

Find on pages 74-75



Wesco is ISO 14001 certified:
2015 and ISO 9001: 2015,
by SOCOTEC
Certification France,
for product design and distribution

Visit us online www.wescona.com